

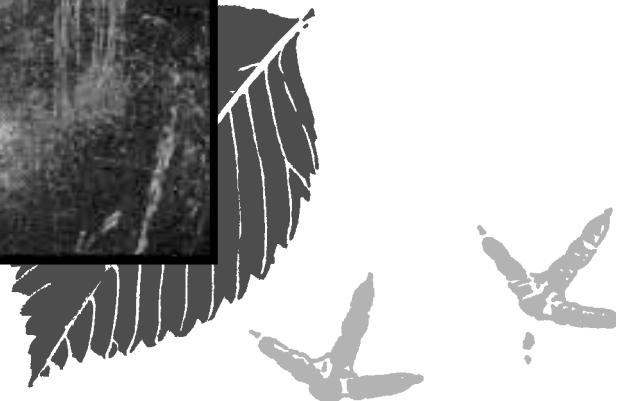

# A LANDOWNER'S GUIDE TO WOODLAND WILDLIFE MANAGEMENT



*with emphasis on the ruffed grouse*

*By Stephen DeStefano, Scott R. Craven,  
Robert L. Ruff, Darrel F. Covell  
and John F. Kubisiak*

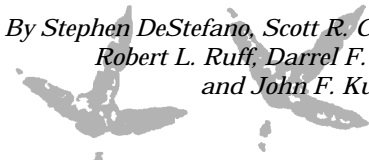

*Cover photo of the Leopold shack, Leopold Memorial Reserve, Baraboo, Wisconsin by Darrel Covell*

*University of Wisconsin–Madison, University of Wisconsin–Extension, Wisconsin Department  
of Natural Resources and the Ruffed Grouse Society of North America*

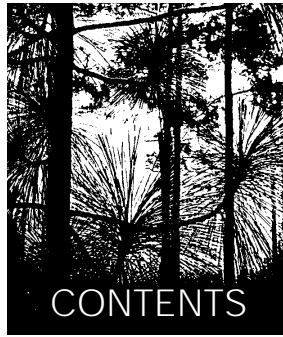

PREFACE iii

INTRODUCTION v

Focus on the ruffed grouse vi  
The Wisconsin private woodland owner:  
a profile vii

- 1 A FOREST ECOSYSTEM PRIMER 1-6
  - Wildlife needs 1
  - Wildlife management principles 2
  - Forest succession: the growth of  
a woodland 4
  - Managing the forest as an ecosystem 6
- 2 THE NATURAL ZONES OF WISCONSIN 7-10
  - The Northern Forest 8
  - The Eastern Deciduous Forest 9
  - The Central Sand Counties 9
  - The Western Upland 9
- 3 DESIGNING A HABITAT MANAGEMENT  
PLAN 11-14
  - Set management objectives 11
  - Inventory and evaluate your land 12
  - Seek professional assistance 13
  - Finalize your management plan 14
- 4 MANAGING YOUNG FORESTS FOR GROUSE  
AND OTHER WILDLIFE 15-30
  - Evaluate your land's potential 15
  - Aspen management 17
  - Oak-hickory management 21
  - Conifer management 24
  - Northern hardwoods management 25
  - Alder management 25
  - Shrubs 26
  - Food and cover plantings 27
  - Reserve trees 27
  - Preservation 28
  - Diversifying your woodlot 28
  - Do-nothing cover types 29
  - Odd areas 29
  - Openings 29
  - Brush piles 30
  - Access 30

- 5 MANAGING MATURE FORESTS AND THEIR  
WILDLIFE 31-35

What is a mature forest? 31  
The value of mature forests 33

- Turkeys 33
- Squirrels 33
- Woodpeckers, wood ducks and  
other cavity-users 34
- Songbirds 34
- Mammals 35
- Reptiles and amphibians 35

- 6 FINANCIAL CONSIDERATIONS 36-39

Marketing timber 36  
Seven steps to successful timber harvest 36  
Cost-sharing programs 36  
Tax considerations 38

CONCLUSION 40

REFERENCES FOR FURTHER READING 41-42

Woodland wildlife management 41  
Ruffed grouse ecology 41  
General wildlife 42  
Field guides 42  
Forestry and woodland management 42  
Controlling wildlife damage 43  
Financial considerations 43  
Tax guides 43  
Record systems 43

APPENDICES 44-55

A) Some common forestry terms 44  
B) Sources of publications 45  
C) Sources of wildlife plants 46  
D) Cavity-using birds of Wisconsin 48  
E) Wisconsin's Recreational Use Statute 50  
F) Sample timber sale contract 53



## *Preface*

*W*e developed this publication to help you—the private woodland owner—manage your property for enjoyment and profit, for the betterment of wildlife habitat and populations, and for the overall sound stewardship of Wisconsin’s natural resources.

Though we focus on the very popular ruffed grouse, you will find advice to benefit virtually all wildlife species found in wooded habitats. In fact, a management activity targeted to one species often has an impact on many others. A “cookbook” approach to managing woodland wildlife won’t work, because the management “recipe” for each property is

slightly different. We hope this publication will clarify some of the many reasons why this is true.

Using this guide and some of the references and contacts it suggests, you will be able to maintain or improve your land as productive wildlife habitat, whether you are a first-time landowner or a seasoned veteran.

The authors wish to thank the many individuals who contributed to and reviewed this publication, especially Dan Dessecker, Michael Foy, Deedee Wardle, John Keener, Jeff Martin and Ken Sloan.

### *A note on stewardship*

We targeted this guide to woodland owners with specific forestry and wildlife objectives, such as improving habitat for ruffed grouse. While such objectives are perfectly valid and attainable, we want you to take note of recent trends in the way woodland owners view their land and their role as woodland stewards—and also in the way society as a whole perceives the responsibility of woodland owners.

We use many terms which refer to new programs and concepts. These deserve your consideration. Biodiversity, habitat fragmentation, conservation biology, ecosystem management, endangered and threatened species—these and other notions all imply certain responsibilities for you as a landowner. Some concepts repackage old ideas, some arise from new information about how forest systems work, and some reflect societal priorities. Regardless of the source, in the future all landowners will likely be urged to factor such considerations into their management activities. Some programs, such as endangered species protection, may determine which activities will or will not be allowed on your land.

We have tried to point out some of these concerns throughout this guide, but we also strongly urge you to keep abreast of new programs and ideas. We encourage you to be sensitive to your critically important role as steward of an environment shared and depended upon by many forms of life.



## *Introduction*

**F**orests are one of Wisconsin's most important natural resources. They provide economic, recreational and aesthetic benefits and make up nearly 15 million acres (43%) of the state's total land area.

Many woodlands are publicly owned, especially in northern Wisconsin. Others are controlled by corporations or industry. But at least 370,000 private citizens own woodlands in Wisconsin. Their holdings make up about 60% of the state's forested habitat.

Forests provide a refuge for many kinds of wildlife. In the past, most wildlife management programs have been directed toward public lands. But because most land in Wisconsin is privately owned, landowners are now encouraged to develop and maintain wildlife habitat on their land. University of Wisconsin-Extension, the Wisconsin Department of Natural Resources (DNR), and many private groups all share a common interest in promoting wise resource management on Wisconsin's private lands. This guide is a product of that interest.

Wisconsin's forests range from small isolated woodlots surrounded by agricultural lands in the southeast, to large stretches of conifers and hardwoods in the north. Many wildlife species depend on some form of woody vegetation. A few, such as black bears and timber wolves, need many square miles of forested habitat; others, such as squirrels, can live in small woodlots. Some species prefer deciduous forests, others coniferous. Some birds require uniform expanses of mature trees for nesting, while ruffed grouse and woodcock prefer a mix of young and middle-aged woods. Forests of every size, type and age provide habitat for some kind of wildlife.



*Stephen DeStefano*

Most wildlife management is actually habitat management. A management strategy may be simple, such as erecting a bluebird nest box, but more often it involves manipulating vegetation. Maintaining a forest in a mature state is good management for some wildlife, whereas removing timber enhances habitat for others. Your decisions about woodland management should be influenced by many factors, including your land's potential, your goals, and the conservation of Wisconsin's resources. This guide will help you explore management alternatives.

Remember to temper your expectations. Wildlife management is often more art than science. Variations in location, topography, weather, natural events and wildlife populations make it difficult to predict the exact results of any management effort. Nevertheless, this guide offers some proven techniques for benefiting wildlife on your property.

### *Focus on the ruffed grouse*

The ruffed grouse (or partridge) is featured in this publication for several reasons. As the most popular game bird in Wisconsin, grouse offer a challenge to hunters and are also attracting increasing attention from photographers and others who simply enjoy wildlife. Although ruffed grouse are common throughout much of Wisconsin, DNR researchers expect populations to decline if aspen and oak acreage continue to decrease. Here is an obvious opportunity for the woodland owner to maintain habitat for this popular species.

A great deal of research has been done on the biology, habitat requirements, and population ecology of the ruffed grouse. That research provides a sound basis for the habitat management practices described here.

Ruffed grouse management need not be exclusive. Good grouse habitat also benefits woodcock, rabbits, deer, and many songbirds, as well as wildlife predators. The basic principles outlined in this guide can be used to benefit all Wisconsin's wildlife species. Your primary management goals—preservation, timber, wildlife, or recreational—along with your land's native vegetation, will ultimately determine the wildlife species found on your property.

*Tom Martinson, Little Marias, MN (UW-Extension ruffed grouse slide set)*



## *The Wisconsin private non-industrial woodland owner: a profile<sup>1</sup>*

- Private woodland owners in Wisconsin account for an estimated 9,082,000 woodland acres (218,000 private non-industrial woodland, or PNIF, ownership units). At least 370,400 people (12% of the state's population 20 years of age or older) have an ownership interest in this land.
- The average size of woodland holdings is 42 acres, with property ranging from 1 to 9,000 acres.
- Eleven percent of the woodland owners control 50% of the PNIF acres.
- Nearly one-third of Wisconsin woodland owners acquired their woodland within the past ten years.
- Forty-two percent of woodland ownerships are part of an active farm. About one-third farm as their primary occupation.
- The education and income of woodland owners are similar to Wisconsin's population as a whole.
- Woodland owners cite a wide variety of reasons for owning their woodlands. Most list "scenic enjoyment" (69%) and "wildlife habitat" (74%) as most important. The smallest proportions of owners give "motorized recreation" (7%) or "investment," the potential to sell for a profit (18%), as important reasons for owning their own woodlands. "Timber production" (30%) ranks seventh among the ten most important reasons for owning woodlands—fourth, if considered on an acreage basis. Most owners report multiple reasons for owning their own woodlands.



A. Jeff Martin

- Department of Natural Resources (DNR) county foresters, Soil Conservation Service (SCS) personnel and UW-Extension county agents are the most popular sources for professional advice about woodland management.
- Only one of every three woodland owners (37%) obtained outside management advice in the past

decade. For those who solicited such advice, the main purpose was for timber production, harvesting or management information. Although large proportions of owners rate wildlife habitat and scenic enjoyment as important reasons for owning woodlands, very few have obtained management advice on these subjects over the past decade.

<sup>1</sup>Highlights from Roberts, J.C., W. G. Tlusty and H.C. Jordahl, Jr., 1986. The Wisconsin private non-industrial woodland owner: a profile. Wisconsin Coop. Ext. Serv. Occas. Paper Series No. 19. 128 pp.

- Relatively small proportions (3% to 10%) of woodland owners have participated in the forest management assistance programs that are available. The proportions of woodland owners who say they are aware of the programs' existence ranges from 21% to 41%.
- The highest ranked recreational activities—"viewing nature," "hiking," "hunting" and "berrypicking"—are enjoyed each year by over half of all woodland owners.
- Woodland owners report that a wide variety of public incentives could induce them to undertake or continue a woodland management program. Property tax reduction and free or low cost trees (incentives now available but not widely used) are considered essential by most woodland owners. While not deemed essential by a majority, they also felt that state and federal tax credits, low cost educational programs, tax reductions, and assistance in marketing timber and preparing management plans would also be important.
- About half (51%) of woodland owners say they are not interested in developing and carrying out a management plan for timber, scenic beauty or wildlife habitat. About one in four (26%) are interested in developing such a plan. Sixty percent of those interested would require a tax reduction as an incentive; 40% would not.
- Approximately 8.6 million acres (95%) of privately owned woodlands are open to public access, but permission is required on two-thirds of these lands.
- Twenty-five percent of owners who close their land indicate they have problems with trespass. Hunting is the most significant problem for this group of owners.
- The mean size of harvest area for timber sales was 23.3 acres. Twenty-seven percent of the sales ranged from 1 to 9 acres.
- Approximately two thirds (68%) of the owners have never harvested wood products to sell. This group controls 4.2 million acres or 46% of all private non-industrial woodland. More than 70% of all woodland owners agreed that the benefits of the Woodland Tax Law (WTL) or Forest Crop Law (FCL) programs should be made available to those who choose to emphasize wildlife habitat, scenic beauty and recreation in addition to wood production.
- Making the benefits of the Forest Crop Law or the Woodland Tax Law groups available to those who choose to emphasize other purposes in addition to wood production would not in itself encourage a large number of owners to enroll. The majority of owners (52%) didn't know if such a change would cause them to enroll in FCL; 41% didn't know if such a change would cause them to enroll in WTL.
- About two thirds (68%) of woodland owners plan to keep all their woodlands for the next 10 years. "Low available volume," "ruin scenery," and "desire to leave their woodlands as a legacy" were the reasons most frequently given for not harvesting and selling wood products.
- Owners of larger woodland acreages are more likely to harvest and sell wood products sometime in the future than are those with smaller acreages.
- Landowners who currently do not intend to harvest or sell wood products indicated that activities which benefit other forest resource needs (such as wildlife and scenery) or personal financial needs would influence them to change their attitude toward harvesting and selling wood products.
- Almost nine out of ten woodland owners in the Forest Crop Law (FCL) or Woodland Tax Law (WTL) reported the property tax reduction as being a very important reason for participating in the program. Deferring property tax and access to technical assistance were most often called unimportant reasons.
- Lack of information about FCL or WTL, the public access requirement, and the notion that joining is too much trouble, were the most often given reasons for not enrolling in the FCL or WTL programs.
- The FCL's public hunting and fishing access requirement was listed by 28% of woodland owners as a major reason they did not enroll. However, 28% also indicated that the requirement was *not* a significant factor in their decision not to enroll.
- About two-thirds (64%) of Wisconsin woodland owners indicated they harvested wood products, either for sale or for their own use; 70% of these harvesting owners cut firewood for themselves.

*NOTE: Since this survey was conducted, the Managed Forest Law (MFL) has replaced the FCL and WTL (see *Trusty and Rodgers, 1987*). However, it offers many of the same incentives to landowners.*



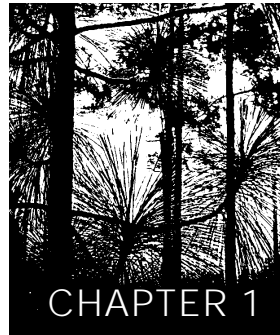

## *A forest ecosystem primer*

**B**efore you begin your management program, it is absolutely essential that you understand fundamental forest and wildlife ecology.

### *Wildlife needs*

All animals need food, water, cover and living space to survive and reproduce. Wild animals vary in the kinds of food they eat. The black bear is a *generalist* that feeds on berries, roots, nuts, leaves, fish, small mammals and carcasses of deer and other carrion. An adult woodcock is a *specialist* because 90% of its diet is composed of earthworms. The ruffed grouse is both a generalist and a specialist at different times of the year. In summer, grouse eat leaves, seeds and berries in addition to insects and other invertebrates.

Throughout the fall, twigs, buds, nuts and fruits make up the grouse diet. During winter, grouse specialize on buds, particularly from aspen

trees. They depend on this high-protein food until spring.

All animals need water, which is usually readily available in Wisconsin. Wildlife can get moisture from standing water, dew-laden plants, and juicy foods such as berries. Ruffed grouse apparently do not need standing water; they get most of their water from food and dew.

Cover is also crucial. Your management can improve its quality. Cover serves many purposes for wildlife: It offers protection from bad weather, provides a refuge from predators and affords a secure nesting site.

Cover and food often go hand in hand—especially for ruffed grouse. A mixture of different age classes of aspen and other trees provides breeding, nesting and escape cover, while also supplying food in the form of buds, twigs, catkins and leaves.

*Animals with a broad diet are called generalists, while those that eat only specific food items are known as specialists.*



*Robert L. Ruff*

There are many factors to consider when managing land for a particular form of wildlife. A species' *home range* is one such factor. The home range of a gray squirrel may be only a few acres, whereas a white-tailed deer or wild turkey might range over hundreds of acres.

As part of their home range, many animals, particularly birds, have *territories* they defend from others of the same species and sex. For ruffed grouse, the territory reserves a breeding area. In spring, adult males (commonly known as drummers) defend 6 to 10 acres of suitable cover for breeding. To a large extent, the size of your property (relative to a species' space requirements) determines both the presence and abundance of wildlife on your land.

Habitat is simply the place, with all its environmental influences, in which a species lives. A suitable habitat fulfills the four wildlife needs for food, water, cover and living space, and permits individuals to survive, reproduce and maintain the population.

For species which can adapt to different habitats, suitable dwelling places often vary widely in different geographic areas. For example, within limits, deer in Wisconsin thrive equally well in southern farm lands, large central Wisconsin marshes, and northern forests. This indicates that an area's capacity to fulfill wildlife needs, and not the land's appearance, determines its habitat value.

### *Wildlife management principles*

Managing wildlife means applying your knowledge of ecology to animal populations and their habitats. You can make an impact on wildlife when you observe ecological principles or consult resource professionals about managing your land.

*Aldo Leopold* emphasized the view that wildlife is a product of the land and the habitat it provides. He also believed that habitat management is the art of producing a sustained yield of wildlife. As a landowner, you can create the necessary habitat and master this art.

Thoughtful wildlife management, based on ecological principles, often uses the techniques of forestry to attain its goals. Chief among these is silviculture, which involves manipulating forest establishment, composition and growth. Healthy wildlife populations are one of the many benefits of good forest management.

Your property may have enough water, cover and space to support ten animals. But if there is only enough food for six, you will only have six. This is the limiting factor principle: The scarcest basic requirement limits the population. Of course, inadequate food, water, cover and living space are not the only things that limit animal populations. Disease, parasites, predators (including hunters), and adverse weather can also reduce populations. Yet these so-called mortality factors usually



---

*Home range describes the amount of space an individual animal uses throughout a season or year. As a rule, the home range is large enough to satisfy an animal's requirements for food, water and cover.*

*Territories reserve something for an animal's use, such as a nesting site, food supply or breeding area.*

*Aldo Leopold, the first University of Wisconsin professor of wildlife management, is considered the founder of modern wildlife ecology.*

have less impact in good habitat that meets the basic needs of wildlife.

Wildlife management, like most management, attempts to achieve an objective—such as increasing grouse or other wildlife populations. In the example above, increasing food quantity or quality will allow your land to support ten or more animals, but eventually another shortage will limit further population growth. In theory, wildlife management attempts to remove these limiting factors until wildlife population goals are reached.

When you improve poor grouse cover, you increase your land's *carrying capacity*—and this should result in more grouse. If you continue to remove limiting factors to improve the carrying capacity of your land, will wildlife populations increase forever? No. Each habitat has certain limits for sustaining a wildlife species. For example, the type of soil may limit food supply, or an inherent species characteristic may prevent unlimited growth. With ruffed grouse, the territorial requirements of breeding males will eventually prohibit further population growth, even in ideal habitat.

Because of territoriality, ruffed grouse populations rarely outgrow the carrying capacity of their habitat. When wildlife does outgrow the land's carrying capacity, as occasionally happens with white-tailed deer, resources are soon exhausted and wildlife densities decline, or in extreme cases, crash.

This may be due to decreased reproduction, increased mortality, emigration, or a combination of these factors. When environmental pressure eases, the population increases, until it limits itself once again. As a result, population size fluctuates around or somewhat below carrying capacity.

The border between a forest and a field creates an *edge effect* that attracts species like the ruffed grouse. Wildlife may be abundant in these areas. Many small-game hunters follow edges, such as the border between upland aspen and lowland alder, to find grouse and woodcock.

The width of this edge, or ecotone, can vary from the sharp break described above, to a gradual transition from one type to another. Generally, the transition type of edge effect supports more wildlife species. In fact, there are certain transitional species, such as the song sparrow, brown thrasher and house wren, that have specifically adapted to these areas.

Also consider the "Law of Interspersion" proposed by Aldo Leopold. Leopold concluded that the more edge per unit area, the higher the game production. We know today that this is true for *some* species in areas with greater interspersion (fig.1).

Yet the need to develop edge and interspersion differs among habitats and location. When managers create small





---

*Carrying capacity refers to the number of animals of one species that can be maintained in a habitat at a given time (often with the condition that habitat damage does not occur). It is commonly used as a measure of habitat quality, although judging by animal density alone can be misleading, because of seasonal variations in animal populations and the land's ability to support them.*

*The edge effect is another principle of wildlife management. The edge where two or more vegetation types meet (known as an ecotone) often supports a greater abundance and diversity of wildlife than either type alone.*

*Habitat fragmentation is the breaking up of large tracts of contiguous habitat into smaller and smaller fragments. It is often a result of human development.*

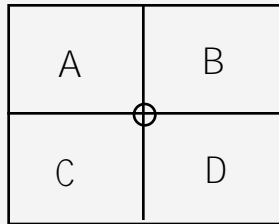
FIGURE 1. INTERSPERSION  
The four habitat types (A-D) meet 9 times more often, while each type's total area remains the same.



▲ Poor interspersion and edge effect

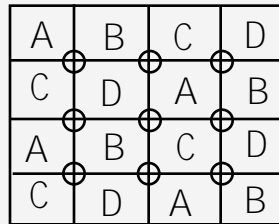

▲ Good interspersion and edge effect

openings in the heavily forested tracts of northern Wisconsin, the areas often exhibit increased wildlife use. On the other hand, much of the forested habitat in southern Wisconsin is already broken up into islands of woodland surrounded by large open areas. Some wildlife species can't use such small parcels of habitat. This phenomenon, known as *habitat fragmentation*, is now viewed as a problem by wildlife managers. If you own a large wooded tract in southern Wisconsin, you should consider preserving this unique community.

As a rule, evaluate the available edge in terms of the wildlife needs discussed here. If the edge barely meets a species' habitat requirements, try to increase its size. Increasing the amount of edge can sometimes be counterproductive because it reduces the area of forested habitat.

If you do decide to manage your land for ruffed grouse, there is another factor to consider—the ten-year population cycle. Ruffed grouse populations rise and fall naturally, with peaks and troughs occurring about every ten years throughout much of their range (fig. 2). Other northern forest species, such as snowshoe hares, also exhibit this so-called "ten-year cycle." The reasons for the cycle are complex and involve interactions

FIGURE 2. Ruffed grouse numbers can fluctuate widely. In some parts of their range, the population highs and lows are cyclic, occurring every 9 to 11 years.

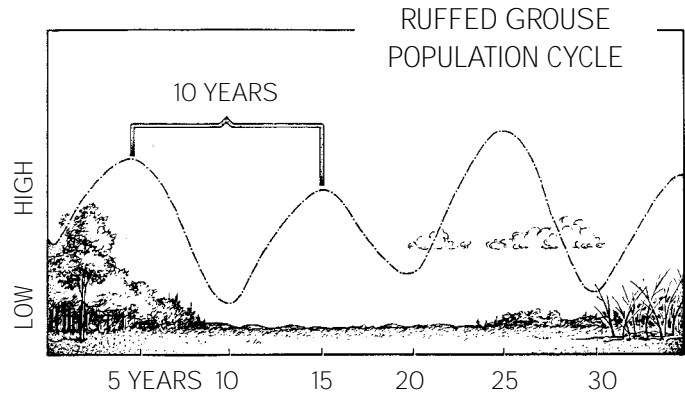

between the quality and quantity of critical winter foods, predators, severe winter weather, disease and parasites. Still, studies have shown that even in low years, grouse numbers remain higher in quality habitat. The more acres of good habitat you can provide, the greater your chances of maintaining grouse populations on your property.

Predator control is often suggested as a solution for increasing some wildlife populations, and it is used in certain situations. However, predator control is expensive, often illegal, and usually effective only in the short-term, if at all. Predators are an integral part of the natural world, and it is important to remember that the ruffed grouse and its enemies, such as the goshawk, have evolved together. As mentioned earlier, severe losses from predators usually indicate inadequate habitat. Over the long run, improvements in habitat quality and quantity show the most potential for enhancing grouse populations.

***Forest succession: the growth of a woodland***

We often think of forests as permanent fixtures on the landscape, existing until they are cut down. But forces which operated long before chainsaws were invented act to change forest vegetation. Various stages of forest development, such as the pole stage, are sometimes treated as separate entities, but forest succession is a continuous process in which one stage gradually becomes another. The process takes place over a period of time. Decades pass before an abandoned field becomes a mature forest (fig. 3).

<sup>2</sup>Forestry terms in boldface are defined in Appendix A.

If a farmer plows the “back forty” in the spring and then for some reason abandons it, annual weeds quickly establish themselves on the bare soil. The weedy field doesn’t look much like a forest, but succession has begun. Perennial plants invade the field, and because they can outcompete annuals for nutrients and space, they will eventually dominate. Shrubs and tree seedlings that grow well in direct sunlight establish themselves next. Hawthorn, aspen, cherry, birch and white pine are among the field pioneers.

After several decades, aspen and other sun-loving trees have reached maturity and the 40-acre field is now a woodlot. Species that originally dominate a field are fast growing and do not tolerate shade; their seedlings cannot grow when the ground is shaded. Young aspen will not survive in the shade of older aspen, but shade-tolerant species will prosper. Oaks and hickories usually survive in partial shade, but in southern Wisconsin these

trees are eventually replaced by more shade-tolerant beech, basswood and sugar maple. When the forest is dominated by trees that can reproduce under the shade of their own canopy, the so-called climax stage is reached. For example, beech and maple seedlings grow in the shade of their parents; as an old tree dies, a young one grows to replace it.

The tree species that make up the climax forest on a particular site are largely determined by the soil and water conditions that influence tree growth. Because of this, oaks may be the climax species on a dry ridge top or south facing slope, while maple and beech replace oaks along bottomlands or on north facing slopes. Climatic factors, such as wind, temperature, and length of growing season are also involved, so that hardy balsam fir, white spruce or white birch may replace sugar maple as the climax species of boreal forests along the Great Lakes. A forest will proceed toward its climax stage unless

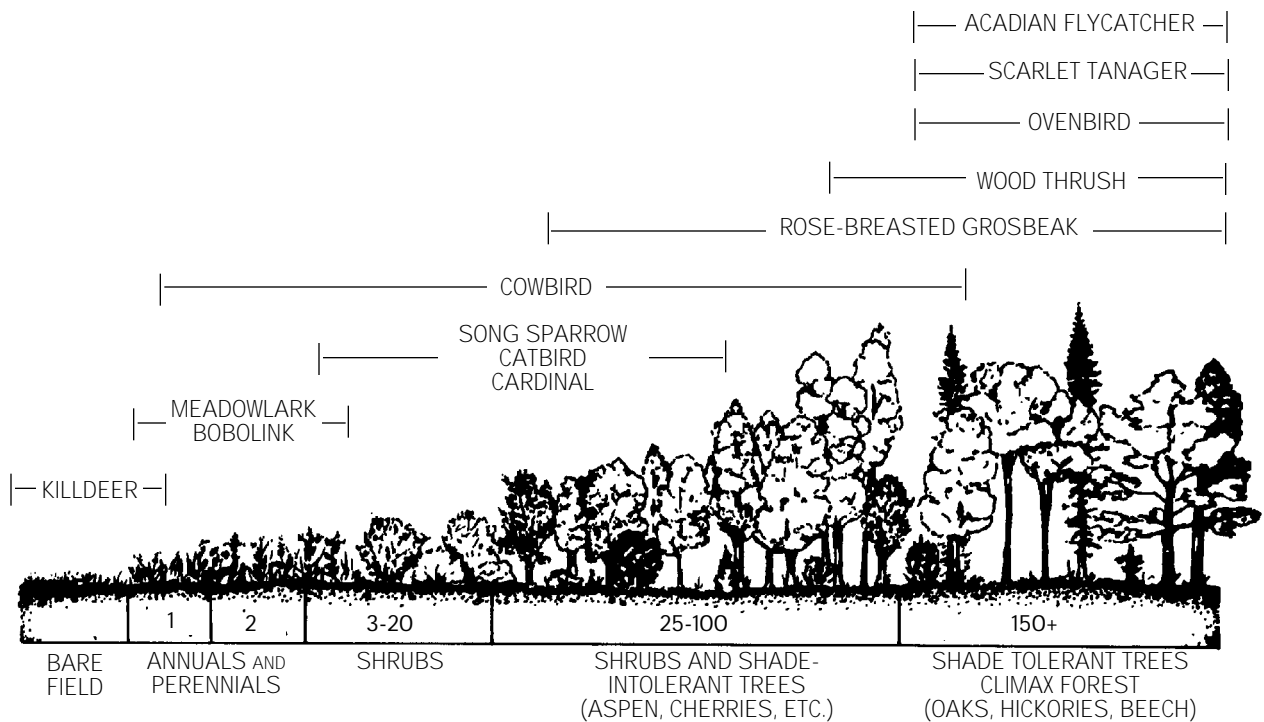

FIGURE 3. FOREST SUCCESSION AND ITS EFFECT ON SONGBIRDS

Forest succession proceeds in stages from bare field to annuals, grasses, shrubs, shade-intolerant trees, and finally shade-tolerant trees—the climax stage. The climax forest remains until fire, wind, disease, cutting, or some other factor disturbs it and sets the forest back to an earlier stage of succession.

Different wildlife species adapt to different stages of forest succession. Songbirds illustrate this well. Some (cowbirds, rose-breasted grosbeaks) can live in several stages of succession; others (song sparrows, cardinals) occupy two stages. Still others (bobolinks in grasslands, acadian flycatchers in mature woods) are specialized to one particular stage. Killdeer can be found around marshes, but will feed and nest in bare fields.

some disturbance (fire, windstorm, disease or logging) changes it. Because these events happen so often during the hundreds of years it takes for a forest to mature, a true climax forest rarely evolves.

Forest succession is an important concept in wildlife management because it predicts the wildlife species you can expect to find in any given stage of forest development (fig.3). Some animals are adapted to live and breed in old fields, some in young forests, and others in mature woods.

There is usually some overlap in the habitat of each species. For example, cottontail rabbits inhabit fields, shrubby areas or young woodlots with dense understories. Some species have very general habitat requirements while others are more specialized. But few species, if any, thrive throughout all of the forest's successional stages.

How does this relate to grouse management? Ruffed grouse are usually associated with the early stages of forest succession. To maximize grouse populations, forests that have grown beyond the early successional stage must be cut, burned or disturbed in some way—then allowed to grow back. Thus, succession necessitates a basic management decision. Do you want to manage your land for ruffed grouse, woodcock and other early successional stage wildlife? Do you want to emphasize older stages that provide habitat for species of mature forests, such as pileated woodpeckers? Or do you want to try (if your property is large enough) for a mixture of both?

### *Managing the forest as an ecosystem*

A forest is a biological community dominated by trees and other woody vegetation. An ecosystem includes all the environmental elements, both living and non-living, that contribute to a community. A forest ecosystem encompasses the animals, trees, understory growth, leaf litter, soil, rainfall, groundwater and all the other components that make up a forest. Wildlife is a part of the ecosystem in which it lives, and each species is influenced by all facets of the ecosystem.

Managing natural resources wisely is often interpreted as using resources to benefit the site, the landowner, or the public—depending upon which interests are being considered.

There is nothing really wrong with this philosophy. Nevertheless, many owners overlook a woodland's many potential values by narrowly defining use and restricting their management schemes. Thus, woodlots are often managed only for timber production, watershed, wildlife or recreation. But every forest is a watershed because some rain falls on it. Every forest has some wildlife, aesthetic, conservation and recreational value. The impact of these values varies among woodlands and among woodland owners.

As the manager of your woodland, you decide which uses to favor. One option is to produce timber on land that is managed for wildlife; in fact, timber and wildlife management often complement each other. Some tradeoffs between various land uses will always be necessary. Sawtimber management may require you to compromise ruffed grouse habitat. Likewise, managing for grouse, woodcock and deer may adversely affect species that require large tracts of mature forest. If your property is large, you may have more flexibility for managing diverse habitats. But you will need to establish priorities and realize that you cannot support everything in the same woodlot. Vegetation, soil, water and wildlife are all interrelated; conserving them is the concern of forest ecosystem management.

At this point, you may be wondering about the potential conflict between managing an ecosystem and managing for a single species. After all, isn't this guide primarily about managing young forests specifically for ruffed grouse? Yes, but you must exercise caution with single species management. All the applied management disciplines—forestry, agriculture, soils, as well as wildlife, fisheries, and range management—have been criticized for manipulating natural systems without regard for their complex interrelationships. But a healthy ecosystem provides all of the different forest types necessary to support its native flora and fauna.

In this time of wildfire control and huge acreages of middle-aged forests, both ruffed grouse and old-growth songbird enthusiasts have reason for concern. As the manager of your own land, sensitivity to your woodland as an ecosystem will allow you to accomplish your goals, while still protecting the many values that make forests such a unique part of our world.

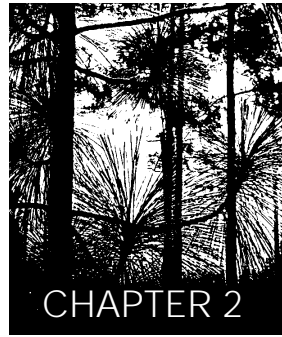

## *The natural zones of Wisconsin*

On the basis of vegetation alone, northern Wisconsin with its mesic forest types requiring moderately moist soils, differs from southern Wisconsin with its combined elements of prairie and eastern deciduous forest types. The Tension Zone (fig. 4a) divides these two regions. The Tension Zone's exact location represents the densest concentration of individual plant range limits (see Curtis, 1959).

Beyond this simple two-fold division, Wisconsin can be further separated into five

natural zones or ecotypes (fig. 4b): *Northern Forest* (including the Lake Superior lowland), *Eastern Deciduous Forest* on the shore of Lake Michigan, *Western Upland* (including mostly the Driftless Area), *Central Sand Counties*, and *Oak Savanna/Prairie* (now mostly farmland) of southeastern Wisconsin. These zones differ in local geology, topography, soils or vegetation. Although most management techniques apply to the first four zones, be aware that special problems or unique situations occur in each.

FIGURE 4a. THE TENSION ZONE

The Tension Zone (shaded area) represents the densest concentration of individual plant range limits. For example, balsam fir is not typically found south of the Tension Zone, but partridge pea, a southern legume, is not found north of it.

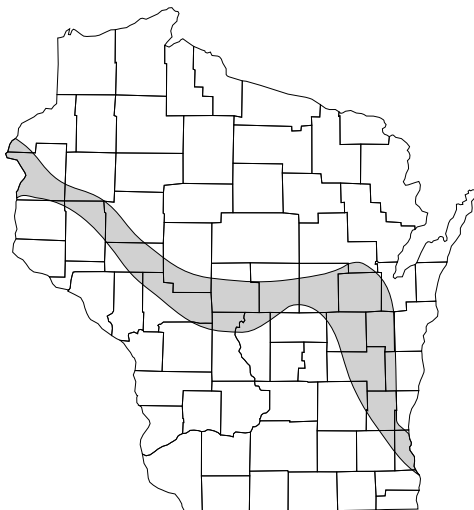

■ Tension Zone

FIGURE 4b. WISCONSIN'S FIVE NATURAL ZONES.

A subdivision of Wisconsin into five natural zones: Northern Forest, Eastern Deciduous Forest, Western Upland, Central Sand Counties and Oak Savanna/Prairies.

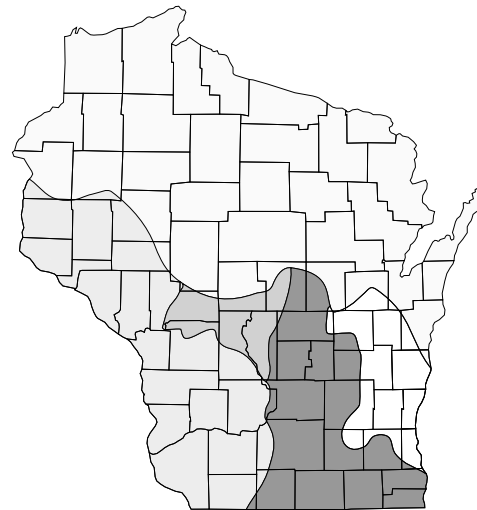

- Northern Forest
- Western Upland
- Central Sand Counties
- Oak Savanna and Prairies
- Eastern Deciduous Forest



*Northern hardwoods.*

Since this guide focuses on woodlands, we will not discuss the Oak Savanna/Prairie zone. Initiating a habitat management program in southeastern Wisconsin depends on woodlot size, type and management potential. But you can still manage for pheasants, quail, rabbits, squirrels, songbirds or other wildlife typical of agricultural land.

### *The Northern Forest*

The Northern Forest is a conifer-hardwood forest in the heavily glaciated northern third of the state. This land is owned by private citizens, industry, Native Americans, counties, and state and federal governments. All of the 1.5 million acres of National Forest in Wisconsin lie within this zone. Agricultural land is widely scattered and devoted to dairy farming and cash crops. Upland forests include pure or mixed stands of northern hardwoods, aspen (popple), fir and birch. The major forest product is pulpwood, followed by fuel wood and sawlogs.

Some of the best ruffed grouse habitat is located in northern Wisconsin where aspen is one of the major forest species. In many

areas nearly two-thirds of the upland forest consists of aspen—offering opportunities to consider grouse habitat when developing pulp and timber management plans.

In the last 60 years, aspen acreage has decreased by about 1% per year, due to natural succession in the face of fire control and weak aspen markets. If you are interested in managing for ruffed grouse, aspen should be maintained where feasible. This may be difficult on sites where competition with balsam fir or northern hardwoods exists. Although small clumps of balsam fir provide excellent winter cover, fir can dominate some areas and reduce habitat quality. Likewise, northern hardwoods will eventually succeed aspen if stands are not clearcut periodically. Unfortunately, larger-sized cuts of over 40 acres are more common in the Northern Forest, which reduces potential grouse response. Keeping clearcuts to 5 or 10 acres will increase age-class diversity and maximize grouse and deer populations.



### *The Eastern Deciduous Forest*

Extensive groves of sugar maple, basswood and elm characterize the Eastern Deciduous Forest. Additionally, American beech reaches its western range limit in this region. The Green Bay and Lake Michigan glacial lobes came out of the northeast to completely cover this area of southeastern Wisconsin. Post-glacial revegetation was dominated by the Eastern Deciduous Forest advancing from south and east of Wisconsin.

This area is the most densely populated of the five natural zones described. It includes the cities of Appleton, Fond du Lac, Milwaukee, Oshkosh and Sheboygan. Much of the maple-dominated forest has been cleared for development and agriculture; however, a great deal of both publicly and privately owned wooded land still exists. Wetlands, including tamarack swamps, are also important in this part of the state.

Notice that the Tension Zone (fig. 4a) dips sharply to the south in the area of Lake Winnebago. This leaves the Door County Peninsula and Lake Michigan shoreline counties with plants and animals found in the Northern Forest as well as the southern forest community. The Eastern Deciduous Forest is marked by glacial features such as drumlins and kettles, including the well-known "Kettle Moraine" areas. Ruffed grouse management is not a common practice, but deer and waterfowl management are important. Wild turkeys are also expanding in range and numbers.

### *The Central Sand Counties*

The Central Sand Counties, with their fine sands and silt loams, are dominated by aspen, jack pine and northern pin (scrub) oak. Immortalized in Aldo Leopold's *A Sand County Almanac* (1949), this area contains a mosaic of cover types. Agricultural development ranges from cranberry bogs to intensive center-pivot irrigation for truck crops. Prominent wetlands composed of spruce or tamarack swamps, sedge marsh, or alder occupy 50% of the landscape in some areas. Uplands are interspersed with fallow fields, crop lands and many shrubs including hazel, blueberry, huckleberry and sweet fern. Plantations stocked with white, red and jack pine are common. Some bottomland hardwoods (silver maple, white ash and river

birch) grow along major drainages. However, uplands dominated by aspen or mixtures of aspen and oak or pine provide the best grouse habitats.

This area is composed of industrial forests, extensive public land under county and state ownership, and a variety of private lands. Industrial forests are managed for wood fiber with some consideration for recreation and wildlife; public lands are managed for multiple purposes. Management effort for timber or wildlife on private lands varies. If you convert aspen stands to red pine, the preferred pulpwood producer, you'll need to make special efforts to avoid excessive damage to wildlife habitats.

Managing aspen for grouse in this region is often hampered by poor pulpwood markets and wet conditions that make logging difficult. Many stands eventually convert to low grade hardwoods or white pine. Yet aspen is still the preferred Central Sands grouse habitat, and your management plans should emphasize it. Just recognize that management recommendations may be harder to implement. You'll probably find a poor market for your timber and poor stocking densities. Larger timber sales in cooperation with your neighbors, or improving access through road construction, may increase logger interest. The aspen management guidelines found in Chapter 5 include suggestions to improve stocking.

### *The Western Upland*

Rugged, wooded hillsides characterize the Western Upland (or Driftless Area) of Wisconsin. Intensive ridge top and valley cultivation supports beef and dairy operations. A dry southern hardwood forest of white, red and black oaks dominates the zone. Other major tree species include hickory, bur oak, sugar maple, basswood, white ash, ironwood and black cherry. Trembling and bigtooth aspen are less common species.

The oak-hickory type dominates the Driftless Area, covering about half of the commercial forest acreage. These forests are relics of earlier days, when recurring fires favored oak regeneration. Northern hardwoods will eventually outcompete the oak-hickory type on the area's rich heavy soils. On lighter soils, succession favors white pine.

Because of these trends and economic factors, foresters may encourage you to convert to northern hardwoods or pine after harvesting mature oak-hickory woodlands. This will probably diminish grouse, deer, squirrel and turkey populations. Nevertheless, by working carefully with your forester, you may be able to maintain oak as an important species in your woodlot.

Aspen grows less commonly throughout the Western Upland, particularly in the northern counties along the St. Croix River. Yet large blocks of aspen, such as occur in the Northern Forest, are rare.

Rather than attempting to convert large areas to aspen, consider expanding the aspen you do have to improve ruffed grouse winter food supplies. You can then concentrate on

developing common local species (such as blackberry, hazel, prickly-ash, sumac, locust and young oaks) into the dense vertical cover needed by grouse.

Grouse may make good use of conifers in the Driftless Area, where good roosting snow is rarely available. Plant conifers with low-growing, brushy branches that provide winter cover. Good choices are eastern red cedar (juniper) on dry sites, white spruce on medium to moist sites, and eastern arborvitae (white cedar) on wetter sites.



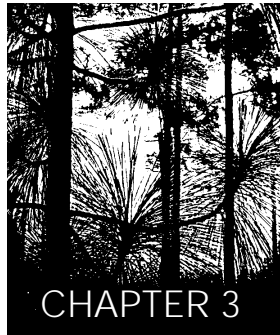

## *Designing a habitat management plan*

**Y**ou should consider several things before beginning a habitat management program for your woodlands. One of the first and most important is your time, because a successful wildlife management program requires several years' commitment. This does not mean that you have to work every day for many years to improve habitat, but it does mean that you must be willing to follow through with your management efforts.

It can take a long time to alter the vegetation and detect a wildlife response to the changes. Don't be discouraged—your efforts will be steadily rewarded in small ways. Each time you hear a ruffed grouse drumming from a new corner of your land, or when songbirds use snags (dead trees) you have preserved or a nestbox your children built, you will reap benefits from your labors.

Abundant wildlife can cause problems. At high populations, some species become pests that compete with other land uses. A good grouse management program will also attract deer to your woodlot. Deer can, and do,

cause considerable damage in Wisconsin. Your woodland could provide sanctuary for a deer herd that raids a neighbor's orchard or cornfields. Deer may make it nearly impossible to establish some of your own plantings, such as Christmas trees or fruiting shrubs. You may need to protect gardens and berry patches from certain species.



Wisconsin DNR

Quality wildlife habitat can also attract potential users of wildlife—especially hunters—who may create safety and trespass problems. But before you close off the wildlife resource by posting your land, remember that wildlife belongs to everybody. The DNR's "Project Respect" offers one option to help you deal with trespass, while providing for regulated public access. Also, Wisconsin's recreational use statute, revised in 1984, limits the injury liability of private landowners (see Appendix E for an explanation of the statute).

The basics are behind us. Let's get going with a management plan for your land.

### Step 1

#### *Set management objectives*

Once you have decided to manage your woods for wildlife, plan your approach. Establish your goals and decide what you want from your woodland. Are you primarily interested in grouse, woodcock and deer, or would you also like to have thrushes, warblers and woodpeckers breeding on your property? Do you hunt squirrels and rabbits as well as grouse? Do you plan to sell some pulpwood to help defray your management costs? Do you harvest fuel wood for your own use or income? Do you enjoy gathering wild berries and nuts? There are many things to think about!

You are not restricted to one goal. You can have several primary objectives (such as managing for ruffed grouse and pulpwood sales), plus secondary objectives. Secondary objectives could include encouraging rabbits by building brushpiles, providing squirrels with nest boxes, and saving snags for cavity-nesters such as woodpeckers. Jot down your ideas and objectives and keep track of references and literature that will aid your management efforts. You may want to keep a journal, including field notes and nature observations. This will be a helpful and

interesting record of your progress and experiences.

Now is a good time to do a little research on forestry techniques and the habitat needs of wildlife species you wish to encourage. Some good publications can be found in REFERENCES FOR FURTHER READING (see Appendix D). Background knowledge on what it will take to achieve your goals will help you evaluate your land and communicate with professionals.

**Step 2**  
*Inventory and evaluate your land*

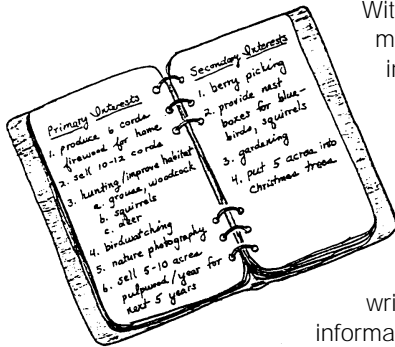

With some objectives in mind, you can begin to inventory the wildlife, vegetation and physical features of your land. Take your journal along and write down any information that pertains to your objectives.

In what successional stages are your woodlands? What tree, shrub, and herbaceous species are present? What is the acreage of various stands of conifers, oaks, aspens and mixed hardwoods? If your land is hilly, record the slope and exposure (northwest, southeast, etc.) of each stand. Take special note of any snags, large acorn-producing oaks (wolf trees) and berry patches. A pair of binoculars and some of the field guides listed in the references will help you make an accurate inventory. You may find a new hobby, a new species for your county, or even a new champion tree!

While examining your own land, observe your neighbor's property, too. Are mature forests, young shrubby woodlands, or old fields nearby? Locate and estimate the acreage of adjacent croplands. Evaluate neighboring land for habitat components you cannot provide, and for their effect on wildlife movement.

Contiguous habitat strips provide travel lanes, while a wide field may be a barrier. You may even want to talk to your neighbors about forming a cooperative habitat management plan. It takes additional planning, but the larger acreage involved may be worth it, especially for such contemporary interests as "trophy deer management."

Collect enough information to delineate the size, type and successional stage of different habitats. For example, to manage for ruffed grouse, record the number and ages of any aspen plus the location and acreage of berry-producing shrubs, alder thickets, small openings in the forest, grape tangles and young conifers. A lack of some of these cover types tells you where to begin your management.

FIGURE 5. PROPERTY COVER MAP.

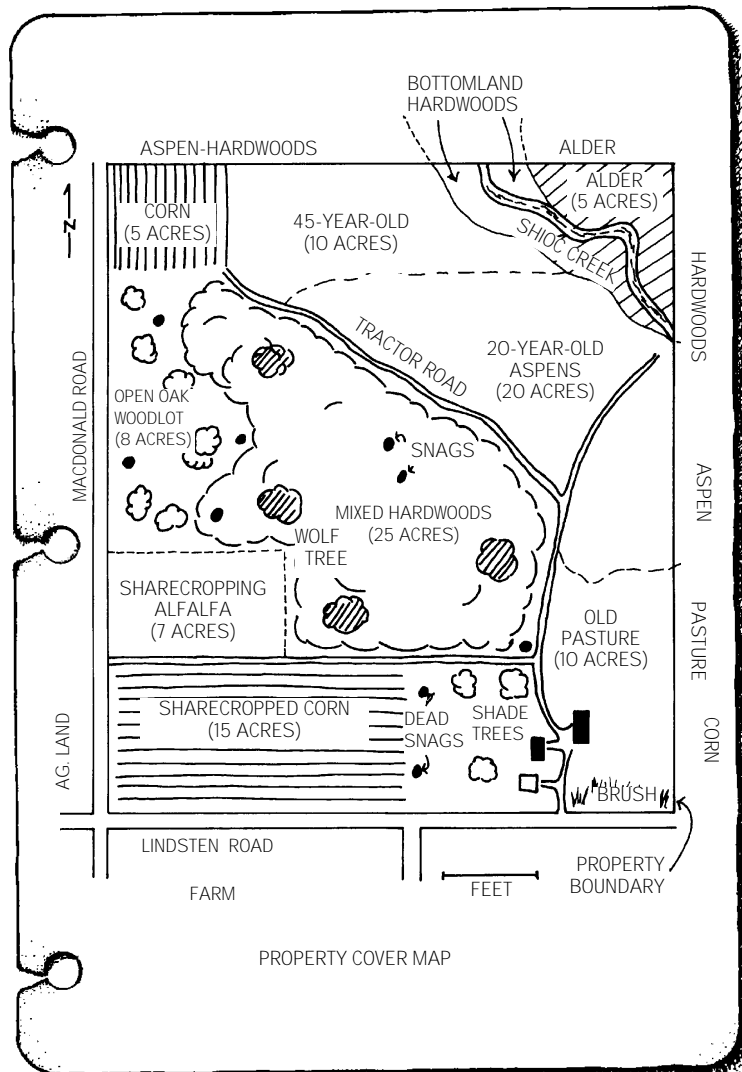

Once you've had a good look at what you (and your neighbors) own, begin sketching a map of your property. Aerial photographs, available at the local Agricultural Stabilization and Conservation Service (ASCS) office, and topographical maps from the U.S. Geological Survey (USGS) are very useful. Start with obvious landmarks (buildings, driveways, fencelines, roads, trails, streams and ponds) and use them as reference points. Next, sketch in property boundaries and the location and approximate size of major timber stands (any similar, identifiable groups of trees).

For example, you may have 15 acres of 10- to 12-year-old aspen, 22 acres of 25+ year-old aspen, 23 acres of mature northern hardwoods and 20 acres of red and black

oaks in your 80-acre woodlot. If you cannot estimate the ages of the trees, the size (DBH or height) will do. You need not measure every tree in the forest, just enough to get a sense of the stand. Then add in the fields, clearings and any patches of shrubby cover. Note the location of snags, dens, wolf trees, berry patches, grape tangles, and other unique habitats, such as springs, rock outcrops or kettles. Don't forget to make note of the habitat types on adjacent lands. Finish your map with a north-pointing arrow and distance scale (fig. 5). This map and your inventory will form the basis of your wildlife management plan.

**Step 3**  
*Seek professional assistance*

FIGURE 6. HABITAT MANAGEMENT MAP.

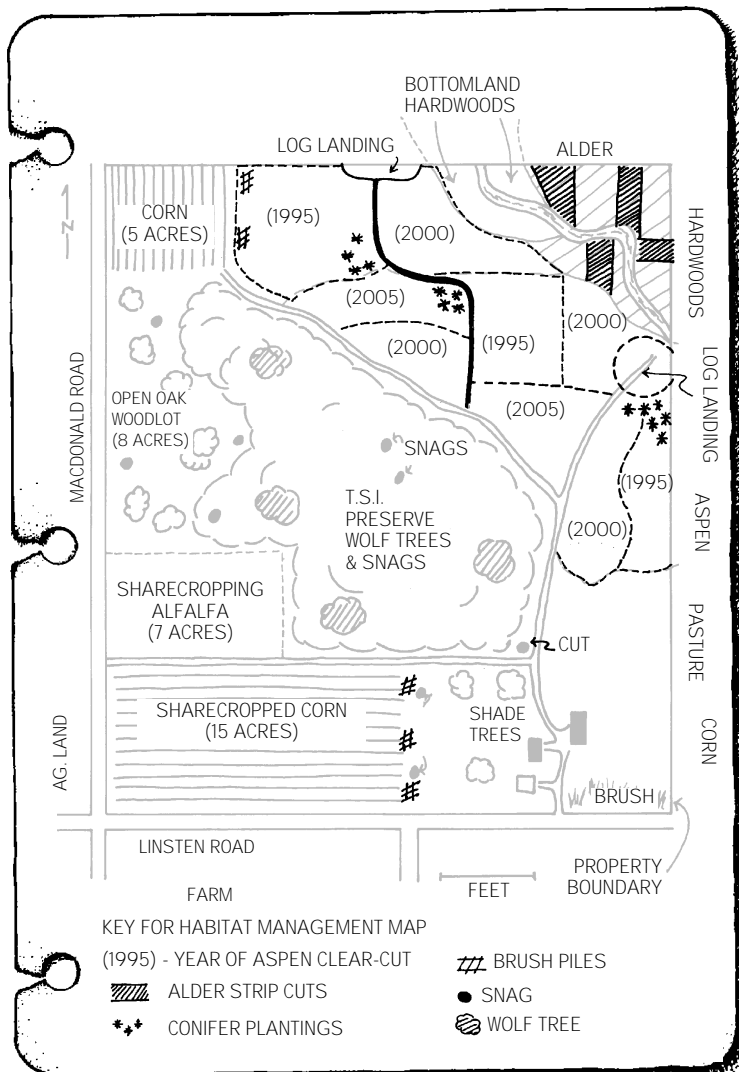

Now that you have a journal with your objectives, inventory, field notes, references and a cover map, consult wildlife and forestry professionals. Each Wisconsin county has a DNR wildlife manager and forester, a UW-Extension agent, a Soil Conservation Service district conservationist, and Land Conservation Department county conservationist. UW-Extension wildlife and forestry specialists and groups such as the Ruffed Grouse Society or Audubon Society can also help. Private consultants and industrial foresters are available in some areas for a fee; they are a good choice if you desire extensive hands-on assistance.

Do not hesitate to consult professionals from various disciplines or agencies; each offers a different perspective. Consultants are most valuable when you get their advice on the probable outcomes of various management alternatives.

Once you have found an advisor with whom you are comfortable, review the journal and discuss your goals. The advisor can determine if your objectives are realistic relative to the local ecosystem, existing vegetation, and financial considerations. Ideally, the professional should survey your land with you. He or she can define areas that have good management potential, help you identify plants and improve your map. Use the opportunity to ask questions and

discuss concerns previously recorded in your journal. If you cannot arrange a professional visit to your property, set up an office consultation. Your journal and cover map should provide enough information to plan your management program.

After the professional assesses the wildlife potential of your property, settle on your final objectives and sketch out a habitat management plan based on your cover map (fig. 6). If logging is needed, a forester can provide information on timber marketing practices, sawlog and pulpwood prices, locations of the nearest mills and names of reliable timber operators and harvest companies.

FIGURE 7. SAMPLE WORK SCHEDULE FOR HABITAT MANAGEMENT

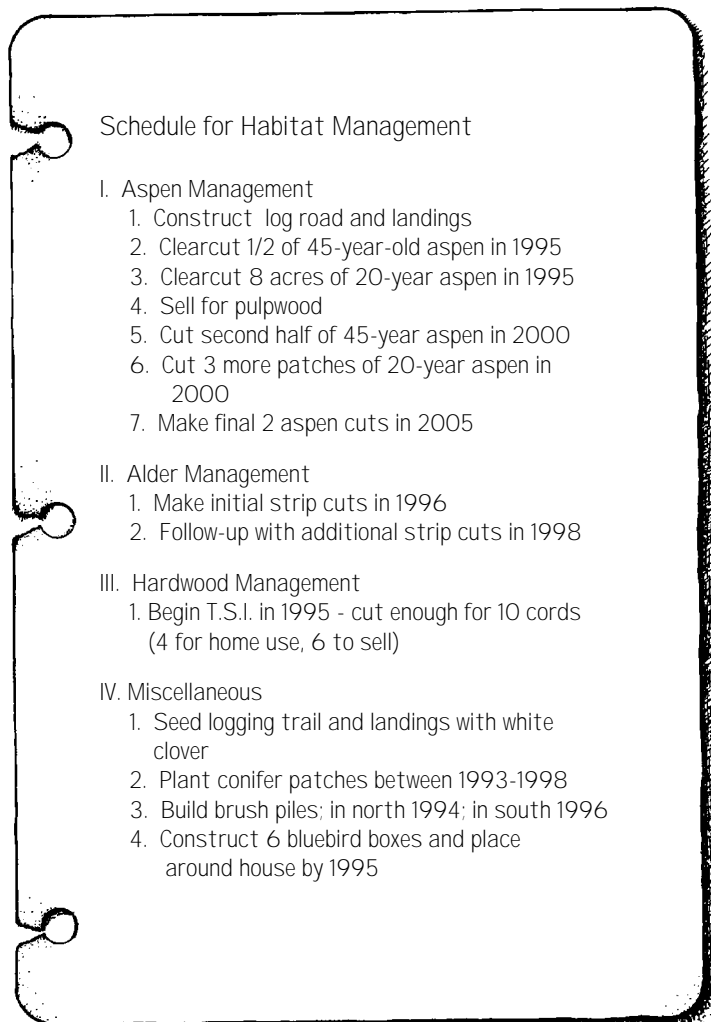

#### Step 4

#### *Finalize your management plan*

Your habitat management plan is nearly complete. You should have the following: an inventory of wildlife and plant species; a description of timber stands including location, size and composition; additional field notes; references, addresses and phone numbers of the local wildlife manager and timber harvesting contractor; a complete cover map and a map showing areas to be managed.

The final step is to draw up a work schedule. Include the primary type of work to be done (for example, clearcut 5 acres of 35-year-old aspen), secondary jobs (use the slash to build two brush piles), the job location and an

approximate timetable for completion. Be realistic. Don't expect to clearcut five acres or plant 1,500 conifers by yourself on a Saturday afternoon. A work schedule will help keep you on course and provide a record of accomplishments (fig.7). Consider enlisting the help of volunteer groups (scouts, 4-H, senior citizens, or conservation clubs) in your area. Take the opportunity to share the joys and responsibilities of land stewardship.

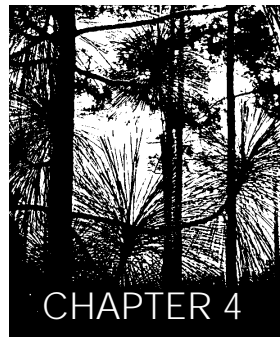

## *Managing young forests for grouse and other wildlife*



*Stephen DeStefano*

**A**s mentioned earlier, you should familiarize yourself with the life history and habitat requirements of ruffed grouse, or any species of interest, before starting your management program.

Some publications that can provide more information are: *The Ruffed Grouse* (Gullion), *Ecology of the Ruffed Grouse* (DeStefano et al., 1984), *Ruffed Grouse* (Madson, 1969), and *Ruffed Grouse* (Atwater and Schnell, 1989). Many publications on wildlife-related topics are included in *A Bibliography of Cooperative Extension Service Literature on Wildlife, Fish and Forest Resources* (Ruff et al. 1993). Details on these and other helpful publications are found under REFERENCES FOR FURTHER READING.

### *Evaluate your land's potential*

If your property lacks wooded cover, you may want to check the references in this guide for farm wildlife management tips on waterfowl, ring-necked pheasants, gray partridge, cottontails, fox squirrels, bobwhite quail or grassland songbirds. Remember to target those species whose ranges overlap your property.

Property consisting mainly of open fields may be better suited for re-establishing native prairie, while low pastures might be restored as wetlands. Restoration can be a particularly satisfying way of regaining some of Wisconsin's lost natural communities, and will attract wildlife unique to these habitats.

Good ruffed grouse habitat is a combination of all the cover types that grouse require throughout the year: dense young woods, brushy thickets, and small natural openings mixed with mature food trees. Although aspen has the best potential for grouse, the key in any forest type is to maintain a mixture of young and middle-aged stands. Most management involves preventing succession to a mature forest stage with an understory that is too open to support ruffed grouse.

As a rule of thumb, you need at least 40 acres for successful ruffed grouse management. Smaller parcels have considerably lower potential, although 20 acres of aspen, oak and shrubs amid neighboring woods can be managed to support a drummer or two in the spring, perhaps a summer brood, and some grouse in the fall. Even 50 acres of prime habitat may be barren of grouse if it is surrounded by crop land. Such an island of woods may be used by woodcock and other wildlife, but is often too isolated to support a grouse population.



Tom Martinson. Little Marais, MN  
(UW-Extension ruffed grouse slide set)

University of Minnesota research has shown that properly managed aspen stands, with associated shrubs, can fulfill the year-round needs of the ruffed grouse. Prime grouse habitat includes a mix of three age-classes of aspen. Stands less than five years old are important as brood habitat for hens and young chicks, and may also attract some drummers. Aspen stands are most productive for grouse during the next growth stage (6-25 years) because they provide excellent cover for drummers, nesting hens and wintering adults. Stands older than 25 years provide the buds and catkins needed for winter food and can include attractive nesting and brood-rearing cover, depending on the shrubs and herbaceous food plants present. It is not surprising that the ranges of aspen and ruffed grouse closely overlap (fig. 8). Some of the highest grouse numbers are found in Wisconsin, Michigan and Minnesota where aspen is common.

You can also manage other forest types for grouse habitat. Lacking aspen, you can create similar structure (the horizontal and vertical arrangement of your vegetation). The most crucial component appears to be stem density. Dense vertical stems protect the conspicuous drummer from avian predators. If you can develop stands with at least 2,000 stems over 5 feet tall per acre (fig. 9), within 300 feet of a good food supply, you should be able to attract drummers and support grouse year round. This can be done with many vegetation types—it's just easier with aspen. In northern Wisconsin, grouse habitat may include young balsam fir or spruce mixed with birch, red maple, alder and hazel. In the central and southern range, dogwood, alder, hazel, prickly-ash, wild grape, oak or red maple may provide food and cover. Tamarack bogs or aspen growing on wet sites may support some grouse, but densities are usually far below those of upland forests.

FIGURE 8. RUFFED GROUSE AND ASPEN RANGES IN THE UNITED STATES.

The ranges of ruffed grouse and aspen closely overlap in North America.

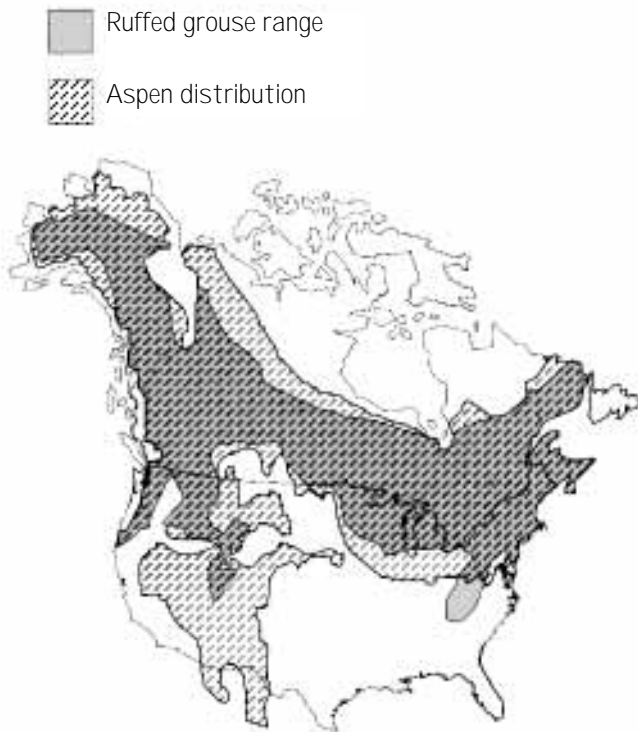



### *Aspen management*

Two aspen (popple) species grow in North America: trembling (also called quaking) aspen and bigtooth aspen (fig. 10). As its name implies, bigtooth aspen has large teeth on its leaf margin, while trembling aspen has smaller teeth and flattened leaf stems that allow the leaves to tremble in a breeze.

Trembling aspen is the most widespread tree in North America. Bigtooth, which prefers drier sites, is limited to eastern North America. Trembling aspen provides somewhat higher quality food and cover for ruffed grouse, but management strategies for both species are similar. The two types will be treated together in these guidelines. Also in REFERENCES FOR FURTHER READING see the DNR's bulletin *Aspen Management on Your Land*.

Aspen provides the major source of pulpwood in the Great Lakes states, while well-formed mature trees are sold as sawlogs or veneer bolts. Fast-growing and short-lived, aspen survive from 70 to 100 years on the best sites. As pioneer species, they grow best in open sunlight and poorly where shaded by other trees. They are unable to reproduce under an



Scott R. Craven

FIGURE 9. ESTIMATING STEM DENSITY.

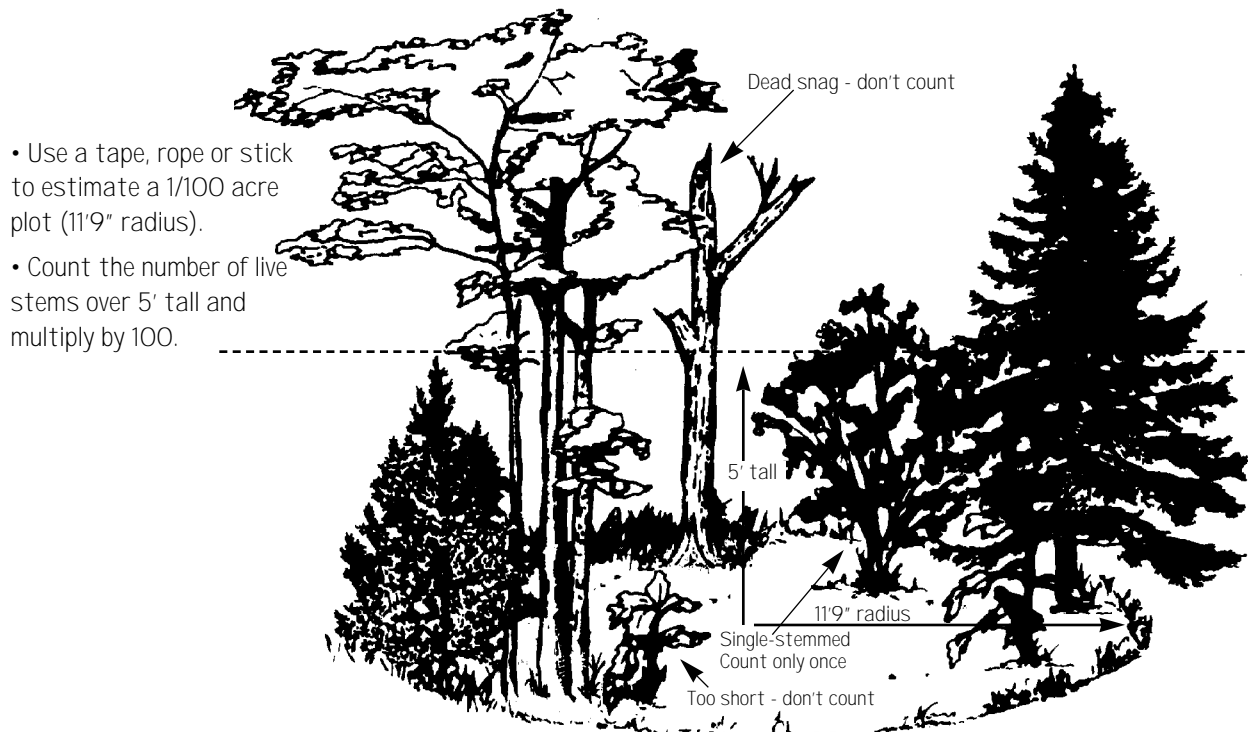

overhead canopy, except along forest edges or steep hillsides where sufficient sunlight reaches the ground.

As a forest ages, aspen eventually die out due to competition from shade-tolerant species. Nevertheless, the aspen in your woodlot can be maintained indefinitely—if you regenerate by clearcutting to allow the sun to reach the ground. Removing mature aspen produces a vigorous growth of young shoots, or suckers, that sprout from the older root stocks to start a new forest. Suckers commonly sprout in uniform stands, often at densities of up to 70,000 stems per acre! These stands provide the dense vertical cover required by grouse; first as brood cover, later, after about five years of natural thinning, for drummers. Surprisingly few aspen are needed to provide adequate regeneration following clearcutting.

Admittedly, there is some irony in cutting a forest to preserve it. What many consider to be the exploitative cutting of mature forests in mountainous regions of the country has given clearcutting a bad name. Huge clearcuts in such areas often result in severe erosion, and the slow regeneration of these forests create at least the impression of ecological devastation. Yet almost all aspen originates with some form of forest disturbance—either from natural causes such as fire and windstorm, or logging. If you remember that cutting an aspen leaves behind a vigorous root system, it is easy to draw a parallel with the gardener, who must periodically cut back rose bushes to keep them blooming. This strategy

would not work for all trees or bushes, but for aspen and roses it works well. Small, well-planned aspen clearcuts on Wisconsin's relatively flat terrain are quite safe, and they quickly resprout without planting. Growth is surprisingly rapid, so there is no long-term denuded landscape to look at (fig. 11). Cutting your aspen at maturity provides the multiple benefits of excellent grouse habitat, aspen maintenance, and income from your land.

Removing all trees and saplings (including other species) over 1-inch DBH should regenerate a dense stand of aspen on most sites. This allows suckers to develop without overhead shading to hinder their growth. Remember, you can always make exceptions for a favorite white pine or oak (see the section on reserve trees).

Specify the 1-inch DBH limit in the logging contract, or make arrangements for treatment after the sale. Otherwise most operators will not take the time to cut submerchantable trees, such as small red maples or conifers, leaving you the back-breaking job of removing these aspen competitors. Don't worry about the slash left behind after cutting aspen or conifer stands. Aspen and conifer slash breaks down within a few years and will not hamper grouse movement as other hardwood slash does. If you have a lot of small hardwoods left lying on the site, you can burn them or invite your friends to cut them up for firewood.

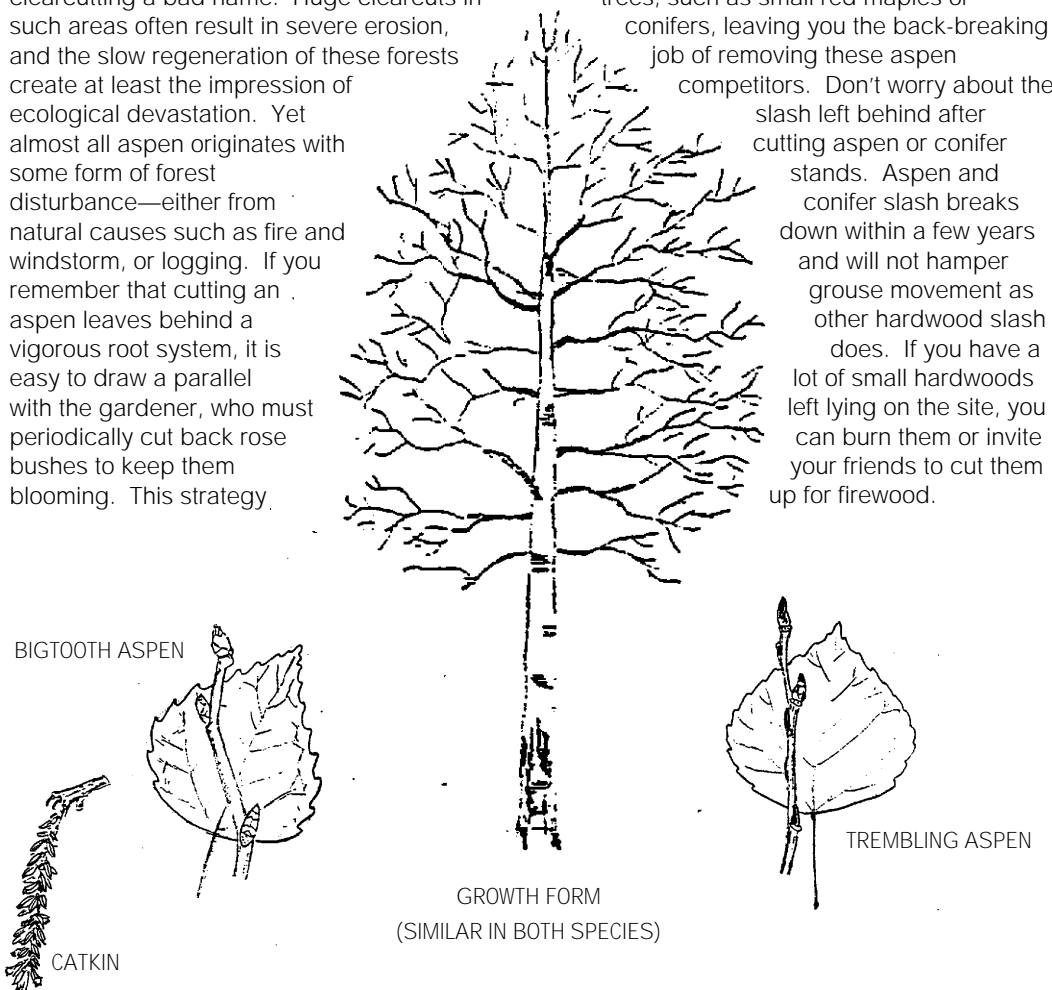

FIGURE 10. FEATURES OF TREMBLING AND BIGTOOTH ASPEN.

On poor or wet sites, common in the Central Sand counties, you may have trouble obtaining good regeneration. Preparing the site after clearcutting will improve aspen and shrub densities. Scarifying the site (disturbing the soil) through full-tree logging or logging when the ground is not frozen will improve suckering. Both methods increase surface disturbance, the former from the rake-like action of dragging a full tree out of the woods; the latter from the logging equipment that chews up the unfrozen ground.

Burn the logging slash where it lies, rather than in piles. This allows the sun to warm the soil and will also stimulate suckering. Seek professional help before attempting to burn slash since the potential for danger exists in any venture involving burning. To encourage the best regeneration, harvest timber only from August to April. During this time, food reserves needed to stimulate sprouting are stored in the roots, protected from loss due to logging.

Now you know how to regenerate aspen. Next, you must provide the three age-classes of aspen needed by grouse within 6 to 10 acres—the approximate size of a drumming male's territory. Remember the Law of Interspersion! The more copies you can create of this basic unit—a drumming territory providing most of the year-round needs of ruffed grouse—the greater your potential grouse population. The easiest way to do this is to cut your aspen in small blocks on a rotation basis, producing a mix of age classes throughout your property.

Follow these four steps when setting up an aspen rotation:

1. *Determine the rotation age.* Foresters recommend a rotation age of 40 years on poor sites (site index less than 50), 50 years on medium sites (site index 50-60), and 55 to 60 years on the best sites (site index over 60). Your forester can determine the rotation age for your aspen; this period then becomes the time frame in which you should plan your grouse habitat rotations.

2. *Select a cutting pattern.* You can use various cutting patterns to attain a mixture of age classes. Researchers have experimented with a number of checkerboard designs, using



Tom Bahri

FIGURE 11. An aspen clearcut quickly returns to its original mature forested state.

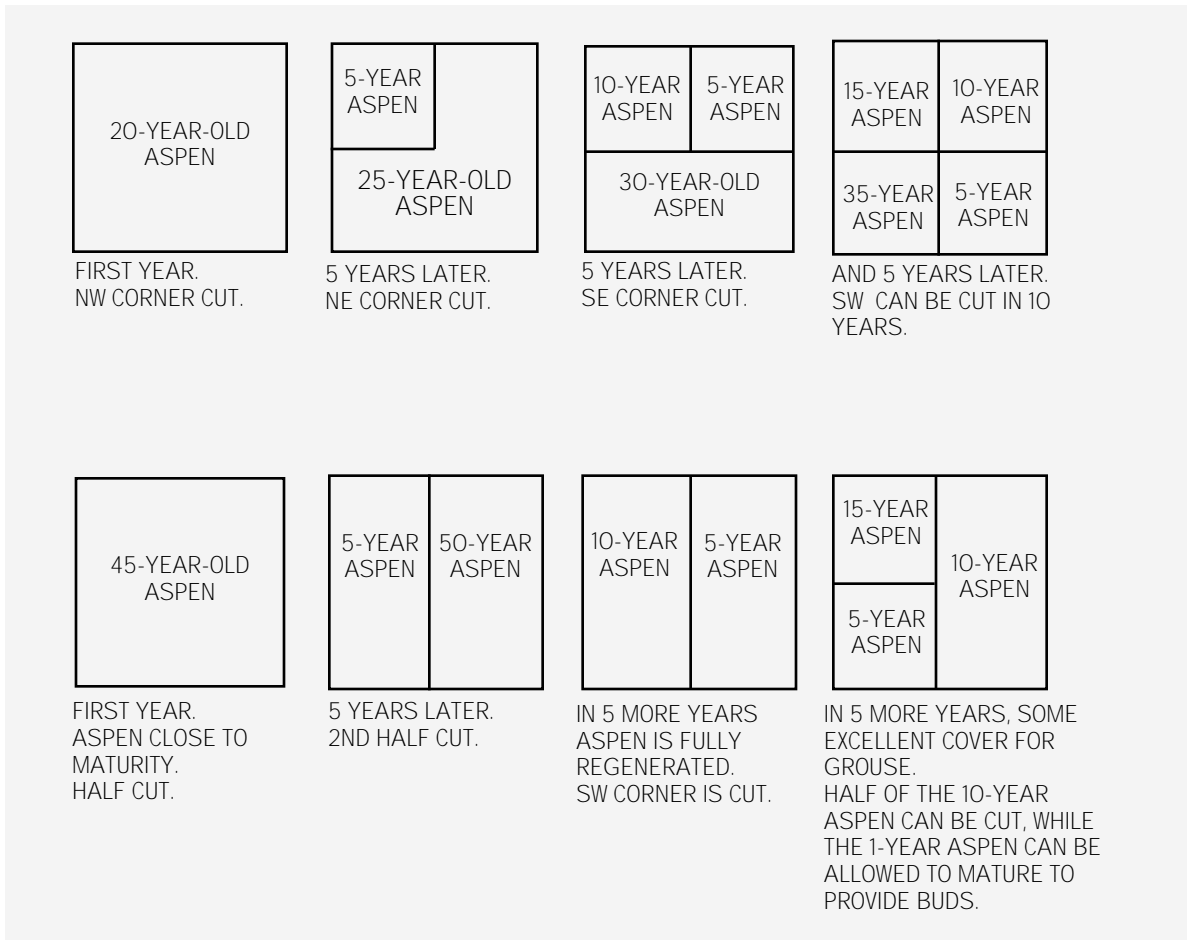

FIGURE 12. ASPEN CUTTING PRESCRIPTIONS FOR TWO DIFFERENT 20-ACRE TRACTS. (All cuts are clearcuts. See Gullion, 1972, for more details.)

clearcuts of various sizes (fig. 12). This pattern encourages a good age-class distribution, and its efficient use of space will maximize the potential number of drumming territories in a given area. Unfortunately, many people find these regular patterns unattractive and artificial. An alternative is to modify your cuts to meander through the landscape and conform to the topography (fig. 13). Such a pattern can simply follow natural stands, or be laid out to mimic their appearance. This pattern can reduce erosion in hilly country.

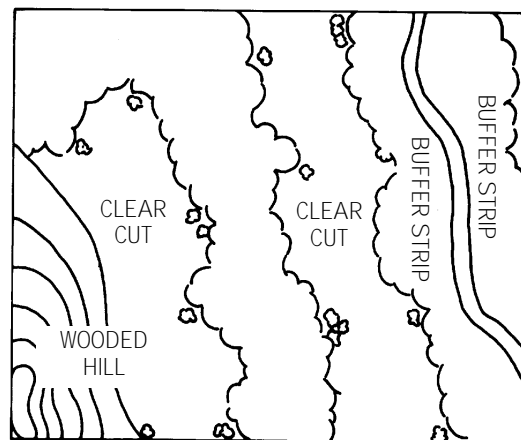

FIGURE 13. STRIP CLEARCUTS. Strip clearcuts with scalloped edges are an alternative to square cuts with straight edges. Leaving vegetated buffer strips along stream banks protects the banks and the stream. When possible, strip cuts should be arranged in a north-south direction to maximize sunlight reaching the ground.

3. *Determine your block size.* How big should you make your clearcuts? If you are using natural stands, you already know, although you can lump or split them. Small cuts are best: 5 to 10 acres is ideal, but loggers may demand 10 to 20 acres. You might convince a logger to cut in 5-acre blocks, however, if your total sale acreage is sufficient. For example, a commercial logger may agree to log your property if he or she can take 20 acres of aspen. Instead of clearing a contiguous 20-acre patch, two 10-acre blocks or four 5-acre blocks could be cut. Loggers may agree to this arrangement if they don't have to move their equipment too far between work areas. Providing good access will make a logger more willing to cut small blocks. *Managing Northern Forests for Wildlife* (Gullion, 1984) has special patterns for use on large properties where clearcuts over 20 acres may be necessary.

4. *Calculate your cutting cycle—the interval between one cut and the next.* Divide your average block size into the total aspen acreage; then divide this into the average rotation age of your aspen. This will tell you how often you must cut to complete a rotation in the available time frame. For example, 5-acre blocks divided into 40 acres of aspen with a rotation age of 50 equals 8 clearcuts to make in 50 years, or a cutting cycle of 6.25 years. On larger properties, multiple blocks will have to be cut during each cycle to complete a rotation on time. The cutting cycle is flexible. You can adjust it to take advantage of good pulp markets or to accommodate a logger's schedule.

Laying out an aspen rotation is not as complicated as it seems. Foresters do it routinely, and they can set up a rotation that will reflect your specific goals and timber situation. For example, cutting prescriptions often require adjustments, depending on the age and condition of the stand. If your stand is 10 to 15 years older than rotation age, deterioration (blowdowns, disease or dying trees) may force you to take immediate action. You may have to make larger cuts in a shorter period of time than you'd like. If most of the aspen is very old, a complete clearcut may be necessary, and age-class development will have to wait.

### *Oak-hickory management*

Oak-hickory woodlots are a valuable asset to wildlife in Wisconsin. In addition to producing acorns and nuts (**mast**), they provide excellent sites for wildlife dens, nests and roosts. The value of this forest type for grouse is directly related to the quantity and quality of understory vegetation. Oak and hickory are attractive to drummers, nesting hens and broods when mixed with low conifers, tall shrubs, and herbaceous food or cover plants.

Oaks are widely adaptable, but grow best on moist, well-drained uplands. Seven species grow in Wisconsin, usually lumped into two groups: the white oaks (white, swamp white, chinquapin and bur oak) and the red oaks (northern red, black and northern pin oak, also known as jack, scrub, or Hill's oak). Oaks, especially young black and northern pin oak trees, retain many of their leaves throughout the winter, which provides insulation for grouse and other wildlife.

Oaks begin to bear fruit at about 25 years of age; older trees with a large DBH and crown are the best producers. The white oak group's acorns mature in one season, while those of the red oak group require two years. Acorns from the white oak group are sweeter and wildlife seems to prefer them, though production from the red oak group is more consistent. Acorn production varies considerably from year to year and from tree to tree within the same stand, with some of the fluctuation caused by late spring frost damage. Complete acorn failures sometimes occur.

Hickories (primarily shagbark) usually grow in mixed stands with oak, and because their needs are similar, are often included in oak management plans. They are not as common as oak and generally mature more slowly. Hickory provides one of our best fuel woods. It has some timber value, and its nuts are valuable to wildlife. Management as mast and timber trees may favor species other than ruffed grouse, but hickories are an asset to any woodlot.

As with aspen, regeneration is a primary consideration in managing oak-hickory forests. Clearcutting or **shelterwood cuts** encourage oak regeneration. To succeed, these cuts require sufficient **advance reproduction** of oak (oak sprouts or seedlings at least 4.5 feet tall) growing in the

understory to successfully compete with other tree species once the oak overstory is cut. Since many of our oak stands originated when repeated wildfires gave them an advantage, regeneration may be difficult with modern fire control.

The oak site quality of your stands will strongly influence your success. If the soil is dark and rich, oak site quality is likely to be high (site index 75+). Without fire, oaks are ecologically unstable in this environment, and any attempt to regenerate them will likely fail. The slow-growing oaks get choked out by all the other vegetation that thrives on these rich sites. No matter what you do, these stands tend to convert to northern hardwoods (maples, elms, basswood and beech), which can survive under shade but are less desirable as ruffed grouse habitat. Any oak cutting will just speed up the process. This leaves you two choices: 1) harvest your oak at maturity and then switch to northern hardwoods management; or 2) dedicate your land to wildlife and allow the oak to live out its natural life.

On average sites (site index 55-74) oak maintenance is more feasible, and oak can usually be maintained using a series of shelterwood cuts, gradually removing the oak canopy to encourage advance reproduction. But competing hardwoods can still be a problem. In this case, you may have to use an earlier rotation period (50 to 60 years instead of the usual 60 to 80 years) for oaks. Cutting oaks at a younger age should reduce **conversion** to northern hardwoods. Short oak rotations reduce the time available for northern hardwoods to establish themselves in the understory, and younger oaks are better stump sprouters. Thin these short rotation stands to increase growth rates and encourage advance oak reproduction.

On poor, sandy sites (index 40-54), oak is relatively stable and may be managed by clearcut or shelterwood treatments to stimulate adequate reproduction. Unfortunately, oak trees may be unprofitable on poor sites. They grow slowly, and less valuable black or northern pin oak predominate. Consider converting the site to pine if income is important. If it is not, these oak stands make excellent wildlife habitat. Clumps of red or jack pine for income, surrounded by buffers of oak for wildlife and fuel wood, might be a good compromise.

Regardless of site quality, there are two basic principles for regenerating oak: 1) the oak advance reproduction must be well established to compete successfully with other woody vegetation in the new stands; and 2) the number of oaks in the new stand will be proportional to the oak advance reproduction before the cut. In other words, if there was good oak reproduction in the stand before the cut, there will be good regeneration after the cut.

You'll need at least 400 stems per acre of well-distributed oak advance reproduction to regenerate the oak type, and you may need more on better sites where competition from other species is severe. Plentiful stump sprouting from cut trees can make up for inadequate seedlings. The red oak group is superior to the white oak group in this respect, and as mentioned previously, young trees usually sprout better than old ones. Your forester will take stump sprouting potential into account when assessing advance reproduction.

Inadequate advance reproduction may require expensive oak planting or weeding out competitors to maintain oak. On large acreages, prescribed burning will favor oak by reducing competition and exposing the mineral soil preferable for oak germination. Burning is difficult and potentially dangerous, however, so be sure to get professional help.

As you can see, maintaining the oak-hickory type is a tricky business—even for foresters. Still, oaks and hickories are valuable timber trees and most foresters will support a decision to manage for this type if at all feasible. If you are committed to maintaining oak-hickory on your property, be sure to obtain professional advice.

Try to maintain a mixture of oak species and other mast producers in your woodlot. For example, if you make a shelterwood cut in a woodlot that has 6 hickories, 15 red oaks, 30 white oaks, and 90 black oaks, you should leave the hickories and red oaks, take a few of the white oaks, and harvest mainly black oaks. Because acorns from the white oak group mature in one year, if a late spring frost causes a poor white oak acorn crop, the previous season's red and black oak acorns, which are just maturing, can supply mast. The following year, the white oaks will likely produce again, and can help make up for the

red oak acorn crop showing the effects of the frost. Likewise, hickories or other mast producers can help compensate for a total oak mast failure due to insects or other causes.

Whenever a mast species is eliminated from a woodlot, whether by cutting without regard for regeneration, or by disease (for example, the nationwide chestnut blight), the wildlife food supply becomes less dependable. By maintaining a variety of species, you imitate nature's way of supporting life by providing diverse food resources.

Oak wilt can be a concern in southwestern and central Wisconsin, but this disease progresses slowly and its effects are usually localized. Red oak is more susceptible to wilt than white oak. Preventing wounds to the bark, and logging or pruning only from October through March reduces the chance of insects spreading the oak wilt fungus to your woodlot. Once trees in your woodlot have been infected, you must cut the root connections between infected and healthy trees to prevent the disease from spreading. Be sure to disinfect your tools with alcohol after working on an infected tree.

*Wisconsin Oak management guidelines\**

This short outline will help you make management decisions about your oak. Starting at level 1, select one of the choices (1a or 1b) and you will be led to a management recommendation or directed to another choice. Continue choosing the statement that best describes your oak stand until you reach a management recommendation. A forester can help you determine which alternative best describes your oak stand.

IF...	THEN...
1a. Oak site index is 75 or greater	☛ Go to 2a or 2b.
1b. Oak site index is less than 75	☛ Go to 4a or 4b.
2a. Stand is mature	Harvest oak and convert to northern hardwoods, or dedicate to old-growth management.
2b. Stand is immature	☛ Go to 3a, 3b or 3c.
3a. Stand basal area is 2/3 or more in oak	Manage for oak or mixed oak and northern hardwoods.
3b. Stand basal area is between 1/3 and 2/3 in oak	Manage for best quality, fastest growing trees, regardless of species.
3c. Stand basal area is 1/3 or less in oak	Manage for northern hardwoods.
4a. Oak site index is 65-74	Manage for oak or mixed oak and northern hardwoods. ☛ Go to 6a or 6b.
4b. Oak site index is less than 65	☛ Go to 5a or 5b.
5a. Oak site index is 55-64	Manage for oak or mixed oak and pine. ☛ Go to 6a or 6b.
5b. Oak site index is less than 55	Manage for pulp or convert to pine or leave as non-economic stand for recreation, fuelwood and wildlife.
6a. Stand is mature	☛ Go to 7a or 7b.
6b. Stand is immature	Thin or wait.
7a. Oak advanced reproduction is adequate (at least 400 stems/acre, 4.5 ft. or taller)	Harvest.
7b. Oak advanced reproduction is inadequate	Establish oak advanced reproduction.

\* Adapted from Sander, I.L. 1977. Manager's Handbook for Oaks in the North Central States. USDA For. Serv. Gen. Tech. Rep. NC - 37, North Cent. For. Exp. Sta., St. Paul. 35 pp.

### *Conifer management*

The quickest way to start an argument among ruffed grouse biologists is to whisper the word conifers. There seems to be universal disagreement about how much grouse use conifers, whether they need conifers, and the effect they have on grouse mortality.

With this as an introduction, here is a suggestion: Use them or not as you and your consultant see fit. Conifers (pines, balsam fir, spruce and cedar) will diversify your woodlot and provide cover for ruffed grouse, deer, rabbits and songbirds throughout the year. Dense patches or clumps of conifers insulate grouse during the cold months. They are pleasing to the eye, especially in winter when they offer some relief from a uniform white and gray landscape.

The quality of coniferous cover varies by species and age. Tall pines and other conifers that have high crowns and lack lower branches provide perfect perches for grouse predators such as hawks and owls. This is especially true during the winter, when a bare deciduous tree would expose a predator's silhouette. In contrast, young spruce or cedar with branches close to the ground provide grouse good protection from predators.

White pine or balsam fir, common understory trees in oak and aspen stands, may contribute to good grouse habitat depending on density

and distribution. Wildlife benefits most when conifers grow in small clumps or strips, rather than distributed throughout a stand. Research indicates that small conifer patches (less than one acre) distributed throughout otherwise thin cover will improve grouse habitat, though conifers should not exceed 30% of the stand. Clearcutting can reduce excessive conifers in the understory. This encourages aspen, shrubs and other beneficial plants.

Many foresters favor red pine plantations for wood fiber production on poor to medium sites, and there is generally a strong market for red pine products. Most conifer plantations are not very productive for wildlife, however, although young stands provide cover for grouse, rabbits and deer. In stands older than 20 years, shading and pruning remove lower branches and the understory usually becomes too open for wildlife.

You can prevent this, however, by increasing tree spacing, reducing basal area, and creating a more open canopy. If you plant at 7 X 9-foot spacing (or greater) instead of the usual 7 X 7-foot spacing, and thin as soon as economical to a basal area of 60 to 80 square feet per acre, you will increase timber growth. This strategy allows enough sunlight to reach the ground to support small trees, shrubs and herbs for wildlife habitat. Additionally, we recommend that you keep conifer plantations to 10 acres or less, spaced 600 to 900 feet apart for optimum wildlife use.



*Robert Ruff*

*Conifer plantations provide poor wildlife habitat.*



Still, from a wildlife standpoint, converting large areas to pine plantations should be avoided, especially if the pines replace high quality aspen or oak habitat. If you are contemplating a new conifer plantation, be sure to consider the costs for planting, herbicides, pruning and thinning—relative to natural stands of aspen, oak or jack pine—when making your decision.

### *Northern hardwoods management*

Northern hardwoods include a variety of species—sugar maple, red maple, basswood, yellow birch, beech and elms. These trees are often found together in a single stand; hence, they are commonly known as mixed hardwoods. Major northern hardwood species are generally long-lived and moderately to very shade tolerant. Sprouting ability varies, but sugar maple, red maple, beech, basswood, ash and elms are prolific sprouters. The early growth and structure of maple and birch stands resemble those of aspen. Red maple can be clearcut to resprout like aspen and provide cover for grouse and winter browse for deer.

Large tracts (40 acres or more) of northern hardwoods with sparse understory growth generally provide poor ruffed grouse habitat. Foresters often recommend long rotation sawtimber growth, which reduces or eliminates habitat for ruffed grouse and other wildlife that prefer early successional stages. But if left uncut, or managed through selection methods, this habitat can attract many mature forest species. Be sure to see Chapter 5 on managing mature forests.

Timber Stand Improvement (TSI) techniques can produce some wildlife benefits. TSI removes some lower quality trees to allow better growth and overall stand quality, similar to weeding and thinning a vegetable garden. The small openings in the canopy created by removing selected trees permit sunlight to reach the forest floor, allowing shrubs and ground cover to prosper for several years. Mast-producers often yield better crops due to less competition for space, sunlight, water and nutrients.

Concentrate cutting for TSI on the most common tree species or where overall growth is suppressed. Be sure to leave den trees, shrubs, vines and other plants valuable to

wildlife. If den or wolf trees are competing with valuable timber trees, they can be girdled and left standing to provide homes and invertebrate food for wildlife. Pole-timber stands should usually be thinned every 10 to 15 years; a forester can make recommendations for your woods. Cost-sharing for TSI is available in most counties (see Chapter 6).

### *Alder management*

Alder can provide feeding areas for woodcock and excellent drumming, brood and year-round habitat for ruffed grouse. Like aspen, alder benefits from occasional cutting to regenerate the stand. If your alder is beginning to thin out, with many downed or horizontal stems present, deterioration is setting in and you should consider a cutting program. *A Landowner's Guide to Woodcock Management in the Northeast* (Sepik et. al., 1981) provides helpful information about alder management.

The vast majority of alder found in Wisconsin grows in almost pure stands on relatively wet sites, often with a dense ground layer of grass or sedge. Such stands often maintain themselves because the alder has a competitive advantage over most other shrubs and trees. Alder stands seldom warrant any special management consideration.

Alder also grows in shrub form with trembling aspen. This occurs especially where the soil is moist throughout much of the year. Where this happens, the alder understory should be regenerated at the same time the aspen overstory is harvested. This may be accomplished by severing the stems from the stump, either by simply running them over with logging equipment when the ground is frozen, or by cutting them with a chainsaw. Alder sprouts will grow from the stump and add to the overall stem density of the regenerating stand.

Another opportunity to maintain this important habitat component exists where pure stands of alder have invaded and established themselves on abandoned agricultural fields. These sites often support earthworm densities substantially greater than surrounding lands with no agricultural history, making them very attractive to woodcock. Such stands can be maintained on a 15-20 year rotation by cutting or mowing 1-2 acre patches or strips every

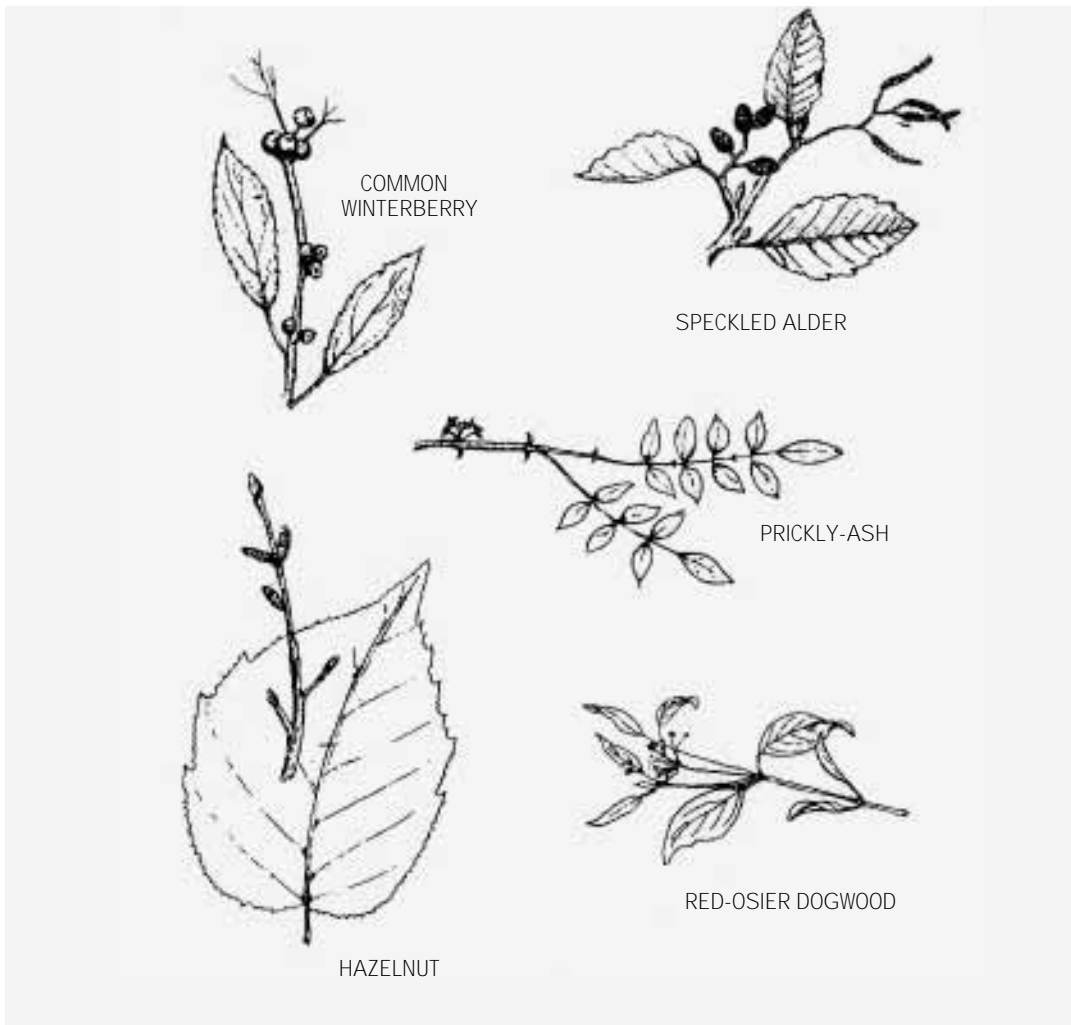

FIGURE 14. Some common Wisconsin shrubs providing food and cover for ruffed grouse.

few years. This pattern of staggered regeneration treatments will ensure that numerous age classes are present at any given point in time, thereby providing a continuous supply of quality habitat for ruffed grouse and especially woodcock.

The highest ruffed grouse drumming counts in Wisconsin have been recorded in mixed aspen-alder stands. Where aspen occurs with alder, make sure you clearcut all alder with the aspen. Otherwise, the alder will shade out the aspen and you will lose this excellent mixed type for grouse and woodcock.

### *Shrubs*

Shrubs are very important to wildlife throughout much of Wisconsin. The density and quality of understory vegetation largely determines the potential of non-aspen forest types as ruffed grouse habitat. If you can raise the density of tall shrubs above 2,000 stems per acre, you should be able to attract grouse—even under northern hardwoods or conifers.

If you have cattle in your woodlot, the first step is to get them out, or at least limit grazing to 25 animal days per acre annually. Overgrazing reduces shrub density, erodes and compacts soil, and destroys the advance reproduction needed to maintain healthy forests.

Shrubs thrive following any disturbance, particularly after clearcutting, shearing (non-commercial tree removal), or burning.

Dogwood, alder, hazel, winterberry, prickly-ash, raspberry and blackberry respond with vigorous growth following treatment (fig. 14). TSI or selectively harvesting marketable trees to increase sunlight penetration will improve shrub growth in mature stands.

### *Food and cover plantings*

Upland habitat can often be enhanced by planting berry-producing shrubs and trees. The additional food and winter cover will increase the carrying capacity of your land. Native shrubs and trees such as hawthorns, dogwoods, viburnums, mountain ash or chokecherry are good choices for Wisconsin. For wildlife plant sources, consult Chapter 6 and Appendix C. Gullion's *Shrub and Tree Planting for Ruffed Grouse* gives valuable planting information.

Shrub planting, because it is expensive and labor-intensive, should generally be limited to areas where food and cover are inadequate. In most of northern Wisconsin, it is more important to preserve herbaceous openings than to plant additional woody vegetation.

Leaving food patches of agricultural grains is not necessary for grouse, but will benefit songbirds, deer, squirrels, quail and turkeys—and draw them to an area where you can easily observe them. Plant food patches near good wildlife escape or resting cover, such as a dense woods or cattail marsh. Corn is the best all-around grain for winter food plots, because it will dependably hold its large, nutritious seed until used. Mixed grain and forage sorghum plots are also good choices. Seed mixes are available from several wildlife nurseries in Wisconsin (see Appendix C).

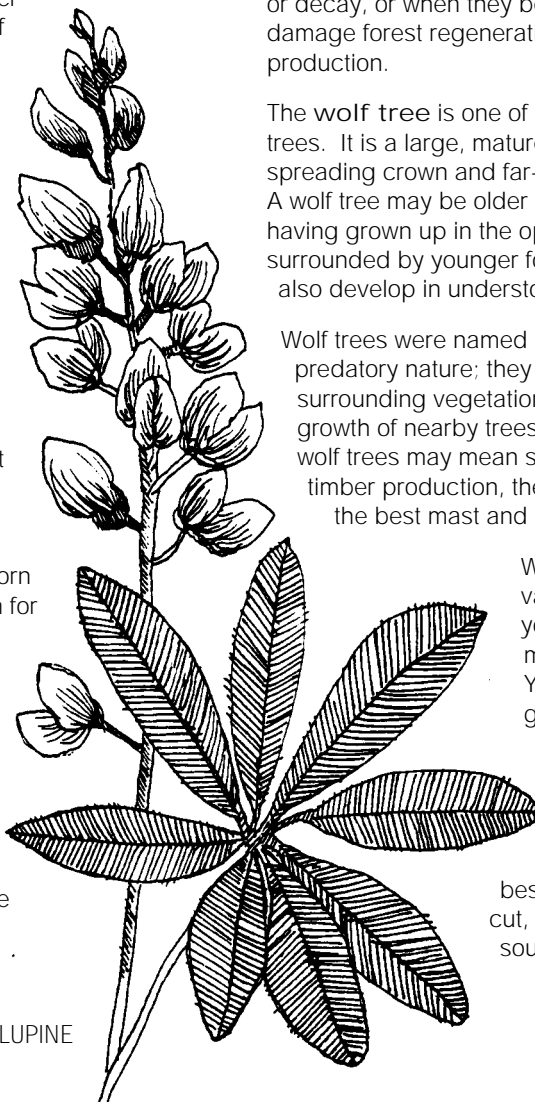

LUPINE

### *Reserve trees*

While marking an area to be cut, note specific trees that have high value for wildlife or other reasons. Reserve these trees until economic or other considerations strongly outweigh their wildlife value. Although this may require small concessions in ruffed grouse management plans, you will improve the overall health and stability of the forest ecosystem.

In southern Wisconsin, a big black cherry is a good example of a reserve tree; prime specimens are rare and their fruit is eaten by many birds and mammals. In the north, extraordinarily tall white pines (known as super-canopy or sentinel trees) are often reserved as nest or perch trees for eagles and ospreys. Any den or mast-producing tree is a good candidate to reserve, as is just about any uncommon species. You can re-evaluate reserve trees periodically, finally cutting them when their valuable wood will be lost to injury or decay, or when they begin to seriously damage forest regeneration or timber production.

The wolf tree is one of the best reserve trees. It is a large, mature tree with a spreading crown and far-reaching branches. A wolf tree may be older than your woodlot, having grown up in the open and later been surrounded by younger forest. Wolf trees may also develop in understocked woods.

Wolf trees were named by foresters for their predatory nature; they tend to crowd out surrounding vegetation and stunt the growth of nearby trees. Though reserving wolf trees may mean sacrificing some timber production, these trees are among the best mast and den producers.

While wolf trees are valuable to wildlife, you *can* have too much of a good thing. Years of past high-grading (commonly known as "tieg-off," because red oak was sought for railroad ties), in which only the best timber trees were cut, has left many southern Wisconsin

woodlots loaded with large wolf trees. Because they have so many limbs, wolf trees often have little timber value except as firewood.

Landowners commonly see these large trees as money in the bank, with the mistaken idea that they are sitting on a valuable timber resource. Foresters, however, see poor-quality trees and an understocked woods. Without management to correct past abuses, it may be generations before natural processes restore the timber-producing capabilities of such land. Taking a forester's advice for TSI in these woodlots will open up the canopy to improve sawtimber stocking and growth rates, and also increase shrub densities for grouse and deer for many years. By leaving one or two wolf trees per acre, you can strike a nice balance between wildlife and timber production. Such use of reserve trees fits in well with Aldo Leopold's ideas on land stewardship—resorting neither to maximum economic production nor total preservation, but giving primary consideration to the overall values of your land.

### *Preservation*

Wisconsin possesses some unique habitats that should be preserved because they are fragile or essential to certain species. For example, in the southwestern part of the state, "sandblows" provide excellent reptile habitat. Other sites that warrant preservation include the patches of wild lupine inhabited by endangered Karner blue butterflies, or the dense stands of mature forest in southern Wisconsin, where rare Worm-eating Warblers dwell.

There is a place for preservation, even in land actively managed for timber production. A large white pine, used for roosting by wild turkeys or valued simply for its beauty, is a good example. Fruit-producing vines and shrubs may also be protected. Although most will vigorously resprout if their root systems are not torn out during logging, it may take quite awhile before they grow large enough to

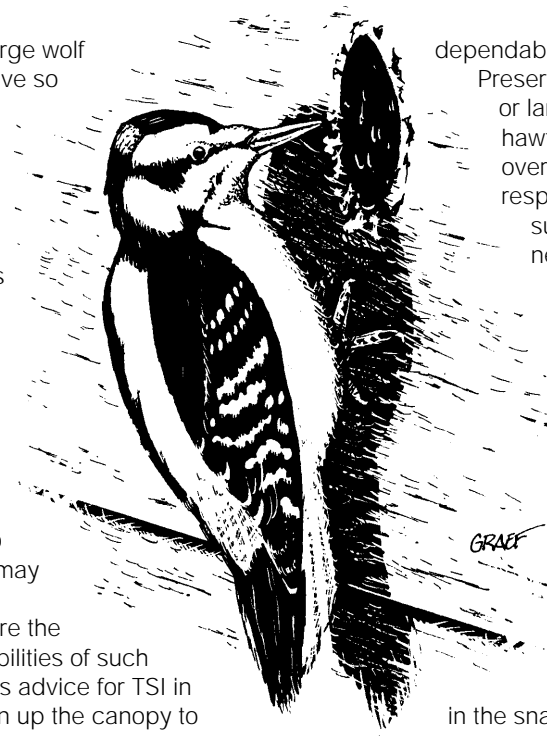

dependably supply food.

Preserving thick grapevines or large-crowned hawthorns will tide wildlife over until your woodlot responds to the increased sunlight with a flush of new shrub growth.

Snag trees that provide nesting cavities and insect food are also an asset to your woodlot. In Wisconsin at least 65 bird and mammal species use snags for nest or den sites.

Some excavate their own cavities

in the snags; others use natural cavities or take over the abandoned homes of others. Try to leave at least five snags of various sizes per acre. The nice thing about snags is that they need not be left at the expense of timber production. Unsaleable trees growing too close to valuable timber can simply be girdled and left standing, providing valuable snags while reducing competition for nutrients and sunlight.

### *Diversifying your woodlot*

You can improve overall wildlife habitat by encouraging a mix of tree species in woodlots that are mostly one type. A few good mast-producing oak trees, or small clumps of oaks, scattered throughout a large aspen clearcut will provide food for squirrels, deer and other wildlife. Another option, which minimizes shading, is to leave a single small stand of oaks (one acre or less) within each clearcut. Likewise, small aspen clones within or at the edge of a large oak stand may be expanded to improve winter food supplies for grouse. Jack pine is another good species to mix in, particularly on poor soils in central Wisconsin. The mixed aspen-oak-jack pine stands common to this area may be the most productive all-around forest type for wildlife in Wisconsin.

When planning any cutting, even clearcuts in a checkerboard pattern, do not lay out perfectly straight borders. Design

meandering edges between the cut area and adjacent woods, and leave some trees and shrubs standing along the cut-line (See fig. 13). Leaving uncut buffer strips, known as riparian corridors, along stream banks will provide travel lanes and mature lowland timber habitat for wildlife. These corridors also prevent erosion, reduce stream siltation, and keep water from becoming too warm. (See *The Benefits of Well-managed Stream Corridors* by Craven et. al., 1987.) This is often important for trout streams, but be sure to check with your local DNR fish manager.

On many cold northern streams, it is better to keep the actual stream bank clear of woody vegetation since shade blocks the growth of aquatic algae essential to stream productivity. Brushing back overhanging vegetation, or creating meadow openings will usually suffice. Leave the remaining woody vegetation to provide the benefits mentioned earlier.

Another consideration when dealing with forest management adjacent to streams is the presence of beavers. Beavers can be beneficial but they may also cause significant damage to roadways, culverts, trout streams and standing timber. There are many factors to consider when managing beaver. For an excellent summary of landowner rights, responsibilities and options in beaver management refer to the DNR's booklet *Beaver Damage Control*.

### *Do-nothing cover types*

Sometimes the best management is no management. Many areas provide some cover for ruffed grouse but are not worth the time, effort or expense required to improve them. Management input would be far greater than the benefits. Good examples are trees or shrubs growing under very wet, marsh-like conditions. Dense grass or sedge associated with alder, willow, bog birch and other wet-area shrubs often offer valuable winter cover, but efforts to improve these areas are usually unnecessary and expensive.

Aspen usually grows on fairly well-drained sites, but so-called "offsite aspen" grows on poorly drained, wet sites, often associated with sedges or grasses. These stands are best left as winter food trees. Offsite aspen produces low volumes of merchantable wood and regeneration is sparse and slow-growing. If the stand originated during a drought, aspen may even fail to resprout following harvest. Unlike upland aspen, some self-propagation

occurs in these stands; as older aspen die, young saplings replace them.

### *Odd areas*

Your property may be providing valuable food and cover to wildlife in ways you never realized. Don't overlook such areas as lowland hardwoods along creek bottoms, sumac groves, wild grape and other shrub, vine and tree associations, hedgerows, ravines and any odd corners not under cultivation. Encourage the growth and wildness of these areas for wildlife habitats.

### *Openings*

Openings in shrub thickets are good additions to grouse habitat, and woodcock use them as feeding and singing grounds. Northern Forest openings constructed by the DNR are heavily used by deer. Such openings increase small mammal and songbird diversity and produce good berry crops. Vegetation responds poorly to openings made on very dry, sandy soils, however, and we don't recommend them.

Logging trails and trail junctions, or log landings (where logs are piled and loaded), may be maintained as excellent small openings. Seeded to white clover and timothy, or left to develop into natural mixes of wild strawberry and other local herbs and grasses, these openings will provide valuable early spring and late fall food for deer and grouse. Annual mowing or light cattle grazing will help keep larger clearings open. Use these methods after August 1 to avoid disturbing ground-nesting birds.

You can also use herbicides, but check with the local DNR wildlife manager or forester before you do. Herbicides can damage nearby trees by moving through root systems. If you or your friends and family enjoy a little physical labor on a cool weekend, cutting invading vegetation with a chainsaw or brushhook is a much better method. On small acreages, annual brushing should not become too burdensome. Use the opposite of the strategy recommended for aspen regeneration—brush during the growing season when nutrients are above ground to reduce resprouting.

### Brush piles

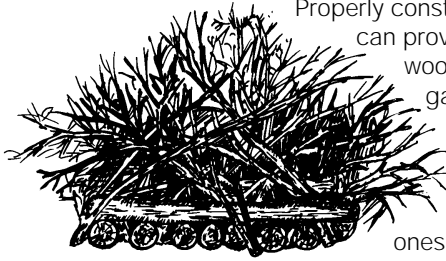

Properly constructed brush piles can provide cover for rabbits, woodchucks, song and game birds for many years. Large piles last 10 to 15 years and provide more protection than small ones, but just about any brush pile will be used by some form of wildlife. Ruffed grouse often use brush piles for cover during the coldest winter days. Once again there are tradeoffs; brush piles may also provide homes for grouse predators such as skunks and foxes.

To construct a long-lasting brush pile, place the heaviest logs on the bottom and lighter branches on top. Start with at least a 6-foot-square base of hardwood logs piled 4 feet high in log-cabin fashion. Fit branches into the base at different angles to lock them together, and continue to place more branches around and over the base. An occasional heavier branch or log will help hold the brushy branches in place. You can make a living brush pile by cutting part-way through a wide-crowned tree and pushing it over, preferably into a dense stand of prickly ash or blackberry. A truckload of discarded Christmas trees also makes an excellent brush pile—providing a home for wildlife instead of filling up a landfill.

### Access

Evaluate your access needs with your consultant. You can then build suitable logging roads or skid trails to improve logging efficiency. Take advantage of current access, dry ridge tops, or uplands and be sure to consider other uses such as skiing, hiking, hunting, birdwatching or berry picking.

Except for large operations, most landowners are happy with skid trails for logging access. They require less land and expense, are less noticeable (especially to trespassers), and are acceptable for most logging if used only in winter. While most owners prefer to maintain access after logging, you can also plant the roads or allow shrubs to grow on them. This will restore your woodlot's natural appearance without seriously impeding future logging access.

When planning access, don't forget an occasional observation site, such as a Leopold bench (fig. 15), blind, or even a small tower or platform overlooking a valley or wetland. A corduroy trail (boardwalk) through a marsh provides access and doubles as a close-up observation platform, although it may also be used by nest predators such as raccoon and mink. Consequently, hip boots or an old pair of sneakers might be a better way to explore a marsh, but anyone who has tried to watch birds while nose-deep in cattails appreciates the advantages of a boardwalk!

FIGURE 15. ALDO LEOPOLD BENCH.

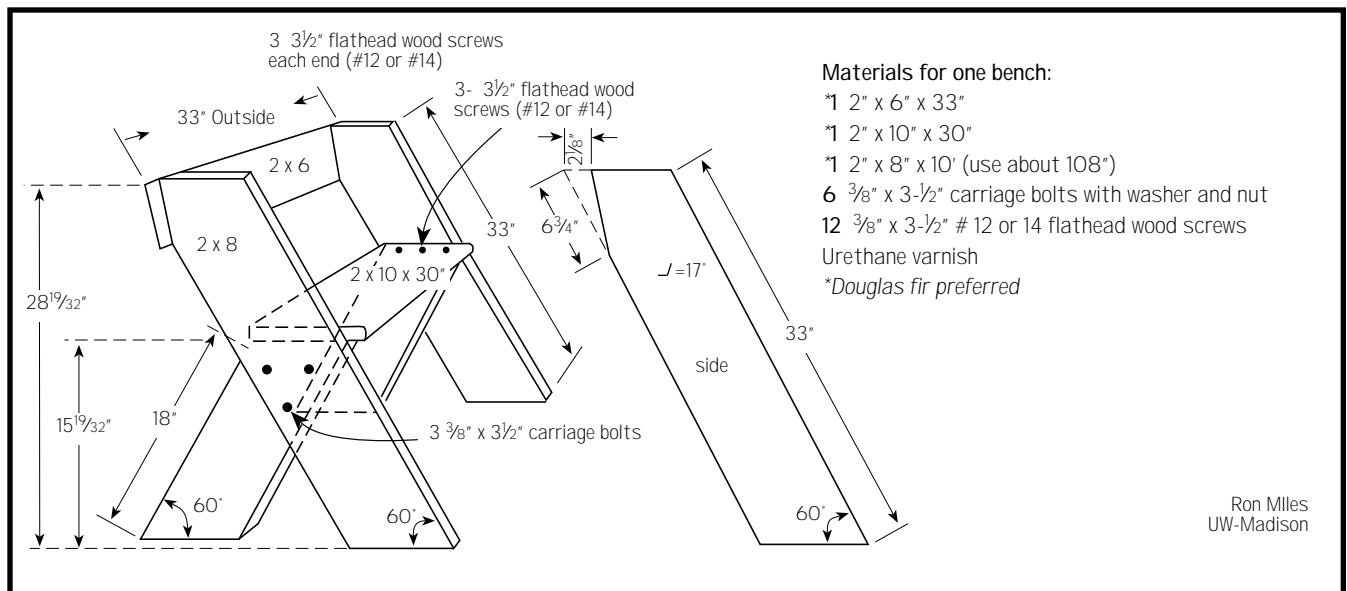

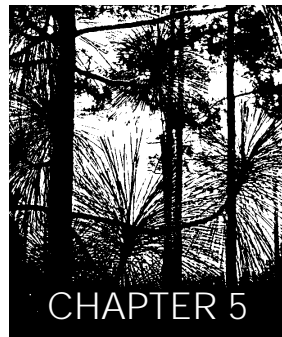

## *Managing mature forests and their wildlife*



*M*any wildlife species share woodlands with ruffed grouse. As we have seen, woodcock, deer, rabbits and many songbirds directly benefit from ruffed grouse habitat management. By making minor changes in your management plan, you may be able to accommodate other forms of wildlife as well. This section describes how to incorporate procedures for other species into your management plan. Mature-forest wildlife habitat suffers when logging or natural disturbances disrupt forest succession. For more information, be sure to consult publications such as *Woodlands and Wildlife* (Hassinger et al., 1979), *Enhancement of Wildlife Habitat on Private Lands* (Decker and Kelley, 1982) or *Enhancing Wildlife Habitats: A Practical Guide for Forest Landowners* (Hobson et al., 1993).

### *What is a mature forest?*

In the section on succession, we discussed how forests proceed from young to mature species (aspen vs. maple), types of forests (aspen-birch vs. northern hardwoods), and forest communities (pioneer vs. climax). To a forest ecologist, terms such as young or mature describe a successional stage. Ecologists concern themselves with descriptive terms such as “new-growth,” “second-growth,” or “old-growth,” which refer to a forest’s origin and form. These terms often carry specific implications for species diversity, community stability, or some other characteristic.

In contrast, foresters use the terms “immature,” “mature” and “overmature” to

describe individual trees or homogenous stands as they relate to some commercial standard (for example, rotation age and diameter class). These terms describe a tree or stand's current condition relative to its desired condition for harvest—regardless of the state of succession.

For example, a typical pioneer forest, such as aspen managed under a short-term rotation, is harvested when trees or stands are mature from a forestry perspective because they have reached the desired age (rotation age) or size for their intended use. Conversely, when a climax northern hardwoods stand is managed for sawtimber by selection methods, only a few select trees are cut during each cutting cycle. The majority of the trees in the stand will be left because they are still immature—they do not yet meet the strict criteria for harvest.

As if things were not complicated enough, wildlife biologists or managers often use these terms literally, referring only to the age or form of a tree in relation to that generally expected of its species. To them, a young or immature

forest is simply not very old or developed for its type, while large, full-grown trees are the primary component of a mature forest. Though many foresters groan at such a casual assessment of age or development, the emphasis here is not on succession or economic condition, but on describing the general value of forests of differing ages for wildlife; for example, mature oaks tend to be good mast and den producers. In assessing the value of a tree to a community, relative to the potential of its species, wildlife managers incorporate the connotations of both the ecologist and the forester. It's easy to see how wildlife management got its reputation for borrowing terms from other disciplines!

When heard in context, the different interpretations of these terms cause few problems. If a professional advises you: "Harvest stand 3, northern hardwoods at maturity," you know that he or she is speaking in a technical forestry sense, and that criteria for assessing maturity will follow. Problems are more likely to arise when people with different perspectives try to resolve a controversial issue, such as harvest plans on public forests.

When foresters use the term overmature, they are describing a tree or stand that is no longer increasing in economic value at a rate sufficient to justify its space and nutrient demands. They are warning that a valuable timber resource is beginning to deteriorate. To a forest songbird enthusiast, however, these stands are not overmature at all, but old-growth. They bristle at the implicit value judgment in the term overmature, failing to realize it represents the technical demands of the timber market, and not necessarily the forester's opinion of songbirds!

Almost every kind of forest is valuable to some type of wildlife, while only certain forest products please the demanding commercial market. Consequently, the wildlife manager's description of forest age or development may not carry the value judgment that the forester's use does (although when used in association with a particular species of wildlife, such as young forests being good for grouse, it often does). As a forest landowner, or as a participant in planning for public forests, you must decide which type of forest suits your interests or ethics, or is best for the situation, society and the environment.



Paul Sievert



### *The value of mature forests*

In the remainder of this chapter, we will discuss mature forests comprised of large, full-grown, older trees—the wildlife manager's definition. Mature forests are among the most structurally diverse ecological communities in the world. They provide a three-dimensional habitat (forest floor, understory layers and canopy), rather than the relatively flat and uniform landscape of early successional stages. Therefore, these forests are home to more bird species than a field or young forest of comparable size. The more layers you develop in a mature woods, the more places wildlife can live and forage for food. Don't overlook the value of snags and fallen logs when developing the layered structure of your woods.

The increased plant and animal diversity of mature forests has a price, however. Abundance of any particular species often declines as diversity increases, resulting in a lower potential yield to humans, whether hunter, berry-picker, or logger. To illustrate some management techniques beneficial to mature forest communities, we have selected several popular wildlife species found in this habitat.

#### Turkeys

By the late 1800s, wild turkeys (once native to Wisconsin), had disappeared from the state due to habitat loss, overhunting and possibly disease. Thanks to the 1976 reintroduction of wild Missouri birds obtained in trade for Wisconsin grouse, we once again have wild turkeys in the forests and woodlots of southern and central Wisconsin. The return of healthy wild turkey populations ranks as one of the DNR's outstanding recent achievements.

Turkeys love to roam, and usually require hundreds of habitat acres. Mast, seeds, insects, agricultural grains and forage such as clover, grasses and sedges are major foods. Blackberries, dewberries and strawberries are also important. Turkeys drink standing water; one source per square mile is a minimum. A good turkey range includes seeps and spring-fed streams that remain open throughout the winter, providing water as well as plant and insect food during periods of deep snow. Hens nest and rear broods in openings and brushy old fields. Turkey poults spend much of their time in agricultural fields and grassy or weedy forest openings as small as 1/4 acre, eating the high-protein insects and seeds they need for rapid growth.

Mixed hardwood stands managed for mature timber provide good turkey habitat. Flocks prefer woodlots of at least 100 acres, although wooded corridors connecting smaller woodlots may make them acceptable to turkeys. If you have a smaller woodlot, be content to harbor turkeys for part of their annual cycle—you will not hold a flock year-round on 40 acres. If you are interested in hunting, providing nesting habitat to attract hens, and consequently gobblers, may improve your chances.

Turkeys prefer to roost in scattered tall trees, including conifers, that rise above the surrounding canopy. A variety of oaks, hickories, cherries, beech and ash supply a steady source of mast. Selective cuts made in these stands to remove overstory will encourage dogwoods, viburnums, hawthorn, grapes and other food-producing shrubs. Planting these and other species, such as apples, may also help attract local turkeys.

If wild turkeys have yet to become reestablished in your area, be patient. Focus your efforts on producing good turkey habitat and wait for natural dispersal to populate your woodlot. Please **do not** stock game-farm turkeys. Hybridization and disease from semi-domesticated turkeys could jeopardize the effort to maintain this majestic bird in Wisconsin.

#### Squirrels

Gray, fox and flying squirrels live in mature, deciduous woods, while the small red squirrels of northern Wisconsin prefer a mix of conifers and deciduous trees. Squirrels feed mainly on mast and tree seeds so squirrel population size is proportional to mast production. Squirrels also need tree cavities for breeding, resting and winter cover. If there are not enough suitable cavities, squirrels will build leaf nests high in the trees, but leaf nests are not as secure as tree dens.

To ensure a sufficient mast supply, you'll need 15 to 25 large oaks or hickories per acre. Red or black oaks tend to produce food more consistently, but white oaks provide more dens, so strive for a mixture. Save as many hickories as you can. Hickories often make up less than 10% of the overstory in Midwestern forests, and squirrels are particularly fond of their nuts. To minimize the impact on squirrel populations, keep your clearcuts smaller than 20 acres and less than 200 yards wide. Try to retain 40% to 60% of the stand in a mast-producing stage.

A typical gray or fox squirrel den has an opening about 3 inches in diameter, a cavity diameter of 6 to 7 inches and a depth of 16 inches. Dens of flying and red squirrels are usually smaller. Den formation usually takes 8 to 30 years, depending on the tree species. Black oak, sugar maple, basswood, cottonwood, beech and elm over 24 inches DBH all produce excellent dens. Artificial nest boxes are easy to build and erect, and are useful in sapling and pole timber stands where a lack of den sites limits squirrel populations. See *Shelves, Houses and Feeders for Birds and Mammals* (Barquest, et.al. 1982) or *Enhancement of Wildlife Habitat on Private Lands* (Decker and Kelley, 1982) for construction and placement instructions.

**Woodpeckers, wood ducks and other cavity-users**

In addition to squirrels, raccoons and other mammals, about 85 North American bird species feed, nest, or roost in dead or decaying trees (Appendix D and Table 1).

Non-game birds are integral members of the forest community and many are economically important. For example, researchers have found that woodpeckers help control epidemic insect populations. To manage for these species you must preserve snags and potential snags. When harvesting timber, use uneven-aged cutting; that is, cut some trees and leave others to grow beyond rotation age. These old trees will eventually degrade and form snags. A one-fifth acre clump of permanently uncut trees within each 5 acres of regeneration cut will provide many species

with snags of proper size (generally greater than 9 inches DBH and 6 feet tall; see Appendix D and Table 1). Leaving uncut buffer strips on both sides of a stream enhances woodpecker populations and controls stream erosion. Many cavity-nesters will also use properly sized nest boxes.

The wood duck is one of our most popular forest cavity nesters, and research shows that aspen is an important cavity-producer for "woodies." It takes aspen about 50 years to form a cavity—which unfortunately is the aspen rotation age on most sites. Nesting cavities should be within one-half mile of a water source with good brood-rearing potential—generally, a wetland with protective vegetation.

To benefit wood ducks:

- Set aside two or three acres of aspen or northern hardwoods within one-half mile of water with emergent cover.
- Extend the aspen rotation age for as long as possible without losing the type, and use uneven-aged management on the hardwoods to promote cavity formation.
- Build wood duck boxes in addition to protecting trees with natural cavities. [See *Woodlands and Wildlife* (Hassinger et. al., 1981) for instructions].

**Songbirds**

Most bird communities can handle some habitat change, such as moderate timber harvesting. Notable exceptions are the species that require undisturbed forests: wood thrush, scarlet tanager, pileated

Species	Time used	Territory size (ac)	Min. no. snags used	Average DBH (in)	Average height (ft)
Downy	All year	10	4	8	20
Flicker	Breeding	40	2	15	30
Hairy	All year	20	4	12	30
Pileated	All year	175	4	22	60
Red-bellied	All year	15	4	18	40
Red-headed	Breeding	10	2	20	40
	Winter	<1	1	20	40

<sup>1</sup> From Evans, K.E., and R.N. Conner. 1979. Snag management. Pages 214-225 in DeGraaf, R.M., and K.E. Evans, eds. Management of North Central and Northeastern Forests for Nongame Birds. USDA For. Serv. Workshop Proc., Gen. Tech. Rep. NC-51. 268 pp.

woodpecker, vireos and many species of warblers and raptors. Your overall habitat management plan should consider these species.

Birds that breed in undisturbed forests share several important characteristics. They are obligate inhabitants of forest interiors—that is, they need an undisturbed forest for breeding and will not reproduce anywhere else. Opening the forest interior exposes these species to predators and cowbird nest parasitism. While many of the species that reproduce on forest and field edges raise two or more broods per year, forest interior species raise only one.

If you have a stand of mature northern hardwoods, aspen-birch, oaks, or mixed conifers and hardwoods, try to preserve as much uncut forest and undergrowth as possible. Work with your neighbors to protect large blocks of mature, undisturbed woodlands.

If you do harvest:

- Extend the rotation period where economically feasible.
- Cut a single large tract, preferably along an existing edge or corner, rather than several small ones in the interior.
- Preserve snags on the cut edge.
- Build brush piles with the slash to harbor the insects on which songbirds feed.
- Plant conifers in the cut area or surrounding your woods for added diversity.

### Mammals

Forests and woodlots with well-developed understories provide habitat for many mammals. Small mammals, such as chipmunks and white-footed mice, may spend their whole lives within an acre of woodland. In contrast, many furbearing predators (mink, skunk, raccoon and fox) travel widely in search of food. Brushy stream borders, ravines, fencelines and hedgerows connecting woodlots, fields and wetlands provide these animals with travel corridors and hunting territory.

When logging or cutting firewood, leave any hollow sections lying on the ground. You can't sell them as sawtimber, and their value as firewood is small compared to that as dens or shelter for ground-dwelling mammals. Depending on their diameter, these logs may be used by anything from the smallest shrew to the largest black bear.

### Reptiles and amphibians

Forest-dwelling herps (reptiles and amphibians) live in forest wetlands, under leaf litter or loose bark, and in holes and crevices. Most woodland species depend on the moist, humid conditions found under the closed canopy of mature forests. Preserving or creating shallow ponds is one way to attract herps to your property.

Many woodland amphibians breed in temporary ponds. Shallow ponds are best, but make sure they are deep enough to retain water until mid-August to allow larvae to develop completely. Permanent ponds will attract wetland species, such as bullfrogs and leopard frogs, that live in or near water year-round. Having both temporary and permanent ponds on your property will reduce competition between the larvae of woodland and wetland species and increase herp diversity.

If you have no permanent ponds on your property, you can build one. You can create small ponds by digging out springs or potholes or by building a weir (small dike or dam) in woodland ravines. On sandy soils, you must line the basin of an artificial pond with clay or sheet plastic.

Although dugout ponds no longer qualify for cost-sharing, if your land is more than one-half mile from a permanent water supply, most county ASCS offices will approve assistance for a low-head dike in a natural drainage. Amphibians, deer, turkeys and waterfowl will all use the resulting pond, especially if it is built in or near wooded cover. However, if beaver are common in your area (as they are across much of the state), don't build an impoundment (manmade body of water) near any timber that you can't afford to lose. What they don't cut down, beavers might flood as they try to improve on your flowage engineering.

Leaving unmerchantable logs to rot away on the forest floor also benefits herps. They live in or under logs and feed on invertebrates supported by the decaying wood. Rotting logs also provide a moist seedbed for mosses, fungi, ferns and trees such as cedar and hemlock. Mortarless stone walls set off road or fence corners nicely, and will provide homes for many herps and small mammals. Any little hiding place located near water is particularly good.

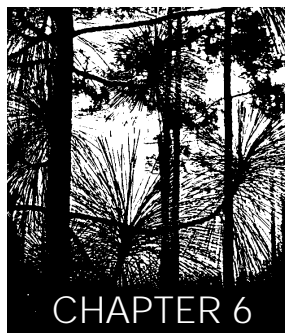

## *Financial considerations*

**F**orest management can be expensive, especially if concessions for wildlife reduce your timber harvest. Consider the following when planning your woodland management program.

### *Marketing timber*

Professional advice is never more important than at harvest time. You may harvest timber only once in your lifetime on some stands, and correcting mistakes is often impossible. Unless you're very experienced, please take advantage of the readily available professional help. *Lake States Woodlands: Marketing Timber* (Martin, Potter-Witter and Lapidakis, 1985) suggests that you harvest only in accordance with your long-term management plan (incorporating a sale contract and several bidders). Also, you should know how various harvest strategies will affect your income taxes.

If you have never harvested timber before, you should visit a current logging site as well as other stands in various stages of regeneration. This will give you an idea of what to expect from a logging operation.

### Seven steps to successful timber harvesting

1. Inventory what you have and what should be cut. The management plan you have prepared will help you decide what and how to harvest your timber to benefit wildlife, what to leave for later harvest, and special trees that should be protected. Your forester can use this information to clearly mark trees or stands to be cut, to minimize chances of mistakes during logging.

2. Plan any new logging roads, skid trails and log landings, and sketch them on your management map exactly where you want them. You can build them yourself or have the

logger construct them as part of the contract or for a fee. Note: In 1994, the Wisconsin DNR Bureau of Forestry will make available a set of detailed *Best Management Practices* (BMPs). These will provide guidelines for forestry practices (including road building and equipment management) designed to protect water quality.

3. Prepare and distribute a sale prospectus to potential buyers. It should include a map and description of the area to be harvested, a listing of species and volumes of wood to be cut, a copy of the timber sale contract, bidding method, bid form with closing date, special considerations for wildlife or aesthetics, bid opening time, and down payment requirements. Most landowners sell their stumpage (standing trees) on a lump-sum sealed bid basis.

4. Select a buyer on the basis of bid and reputation.

5. Complete a timber sales contract (see Appendix F for a sample contract) with the successful bidder, including sale terms, performance guarantees, liability and other concerns.

6. You or your forester should check logging operations to ensure compliance.

7. Plan post-harvest activities such as slash disposal, TSI, site preparation and possibly planting.

### *Cost-sharing programs*

There are many programs available to forest landowners, and those detailed here are available as of 1994. However, keep in mind that programs often change. Let's start with those currently offered by the federal government.



The Agricultural Stabilization and Conservation Service (ASCS) administers the *Agricultural Conservation Program* (ACP) through offices in each county. ACP offers cost-sharing of up to 75% for approved conservation practices. Those of interest to Wisconsin woodlot owners include:

- timber stand improvement.
- site preparation for natural regeneration.
- forest tree plantation establishment.
- permanent wildlife habitat improvements (including impoundments, tree and shrub planting, and woodlot fencing to prevent overgrazing).

The Soil Conservation Service provides technical advice for those installing these practices.

The *Forestry Incentives Program* (FIP) also cost-shares with private nonindustrial forest owners for tree planting (including site preparation if necessary), and timber stand improvement. This program is generally for larger scale forest operations (10 to 1000 acres), and may only be available in counties with significant forest economies. The ASCS provides cost-share funding of up to 75%, and

the DNR provides installation and technical advice. You can receive cost-shares of up to \$10,000 annually, and can agree to fund long-term practices for 3 to 10 years.

Since the 1985 Food Security Act (Farm Bill), the *Conservation Reserve Program* (CRP) has offered annual rental payments for eligible lands taken out of production for ten years. To be eligible, land must have been in commodity crops (such as corn or alfalfa) at least two of the five years prior to signup, meet erodibility requirements, and be currently available for crop production. Tree and shrub planting for windbreaks or wildlife habitat is a qualified use of set-aside lands and will be cost-shared up to 50%. Permanent grass cover also qualifies and may complement your woodlands by providing nesting cover for pheasants, turkeys and songbirds. Provisions also allow for filter strips along streams and ponds and make it easier to qualify if you agree to plant trees. It is uncertain whether this program will continue, so check with your ASCS office for current information on the status of CRP.

In the past, a *Tree Planting Program*, part of the Farm Bill, has been offered to provide up to 3,000 free trees to farmers who have an

approved soil erosion plan or live in a county with an approved plan. The current administration is revising this, but there will likely be some sort of tree planting incentive in the years to come. Your county Land Conservation Department (usually located in the county courthouse, sometimes under the name Soil and Water Conservation Department) can provide you with current information about the programs available.

Another source of nursery stock is wildlife packets, consisting of 100 conifers and 200 wildlife shrubs, available free from the DNR for participating in the *Acres for Wildlife* program. Similarly, 500 trees or shrubs are offered as an incentive for participation in the *DNR Project Respect* program. A limited supply of such wildlife packets of nursery stock is also available for a small fee if you are not interested in these programs. For more information, contact your local DNR wildlife manager. You can also buy trees and shrubs from the DNR or private nurseries (see Appendix D).

The latest incentive for landowners is called the *Forest Stewardship Incentives Program* (SIP). Similar to other programs, SIP cost-shares (50-75%) with non-industrial private forest owners for the following objectives:

- developing a stewardship management plan.
- conserving water quality, soil and other related natural resources.
- controlling erosion and sedimentation from forest land.
- enhancing the timber, wildlife, fish, recreational, aesthetic and environmental benefits of properly managed woodlands.

Top priorities for the SIP include riparian/wetland protection and improvement and wildlife habitat enhancement. To see if your management practices qualify for funding, contact your county ASCS office.

### *Tax considerations*

Taxation of woodland enterprises can be very complicated. The long-term nature of woodland investment makes it crucial to consider taxes in all phases of your operation to assure favorable treatment. Some helpful sources are listed in the REFERENCES FOR FURTHER READING section, but be sure to consult a tax advisor before making any large investments in (or harvests from) your woodland.

Sales taxes apply to most forestry-related purchases, although growing Christmas trees as a business is classified as farming and participants qualify for sales tax exemption. The DNR allows farmers to purchase state nursery stock tax-free by completing a Farmer's Exemption Certificate. More than nominal use of trucks, tractors, saws or other equipment purchased under the farming exemption for forestry requires payment of a use tax.

Several state programs may help you lower your woodland property taxes. The Managed Forest Land law reduces taxes for woodland property owners who follow an approved management plan. If you own at least 10 contiguous acres of wooded property (at least 80% of which must be capable of producing 20 cubic feet per acre per year of merchantable wood) within a single municipality (civil township) you may be eligible for the program. The contract period is 25 or 50 years. Eligible acreage is taxed at a fixed annual rate (85 cents per acre in 1993). In return, you agree to manage your land for wood fiber production under an approved plan. The plan may also recommend practices for wildlife, watershed, recreational or aesthetic benefits. The lands must be open to non-motorized public access, though landowners may choose to close up to 80 contiguous acres by paying an additional \$1.15 in tax on each closed acre. The 85-cent and \$1.15 rates will be adjusted in 1997 and every five years thereafter. At harvest, you will pay a 5% yield tax on the stumpage value of all timber products cut.

The Managed Forest Land Law replaces the previous Forest Croplands Law and Woodland Tax Law, though existing contracts under the

former laws will remain in effect until expiration. The Wisconsin Farmland Preservation Law is designed to protect farmland from urban development, through preservation plans or exclusive agricultural zoning. Along with traditional farming, most towns and counties allow forest and wildlife management on agricultural land. While not lowering property taxes directly, participation earns state income tax credits for eligible farmers enrolled in local preservation programs. You must make more than \$6,000 in gross farm income to qualify. For more information, contact your county Land Conservation Department.

As noted in the Extension bulletin *Wisconsin Woodlands: Income Tax Considerations for Forestland Owners* (Stier et al., 1984), several

provisions of the federal tax code could affect woodland owners. These include the potential to claim an investment tax credit on the costs of planting trees, the recovery of certain management costs as annual deductible expenses, and the possibility of treating the proceeds of timber sales as capital gains.

Tax laws change constantly, and Wisconsin income tax law does not conform exactly to federal law. Be sure to consult your tax advisor for specific provisions that may affect you.

See REFERENCES FOR FURTHER READING for a list of reference guides and tax record systems.



*Tom Bahti*



## *Conclusion*

*M*anagement plans for grouse, or any wildlife, vary depending on location. For example, overgrazing in woodlots and lack of winter cover may be a concern in the Driftless Area; proximity to pulpwood markets is important in the Central Sands; and converting aspen to hardwoods or balsam fir is the major management concern in the North Woods. Planning and professional assistance will help you tailor your management plan to your property. Remember the sequence: objectives, inventory, professional assistance, goals and work schedule.

Resist the temptation to focus on only one aspect of woodland management for simplicity's sake. Try to keep multiple-use concepts in mind—a management goal aimed at producing high quality timber need not

ignore songbirds. Forests are diverse ecological communities that provide a place to live for many species; they all deserve consideration. The emphasis can, and does, vary among landowners. You may be an ardent grouse and woodcock hunter while one neighbor is an avid birdwatcher and another is primarily interested in wood production. However, a carefully planned joint management effort can benefit everyone.

We tend to think of land only as something to own and use, forgetting how much we depend on it. Consider yourself not only a property owner and manager but a concerned steward of the land. Aldo Leopold summed up this philosophy in the foreword to his Sand County Almanac essays:

*"We abuse land because we regard it as a commodity belonging to us.  
When we see land as a community to which we belong,  
we may begin to use it with love and respect."*



*Aldo Leopold*





## *References for further reading*

Prices, where given, are subject to change.

Appendix B on page 45 tells where these references are available.

### Woodland wildlife management

- Craven, S.R. 1981. Wisconsin woodlands: wildlife management. Wisconsin Coop. Ext. Serv., G3097. 8 pp.
- Craven, S.R., and R. Ellarson. 1986. Landscape plants that attract birds. Wisconsin Coop. Ext. Serv., G1609.
- Craven, S.R., G. Jackson, W. Swenson and B. Webendorfer. 1987. The benefits of well-managed stream corridors. Wisconsin Coop. Ext. Serv., G3404.
- Decker, D.J., and J.W. Kelley. 1982. Enhancement of wildlife habitat on private lands. Info. Bull. 181. NYS Coll. of Ag. and Life Sci., Cornell U., Ithaca. 40 pp. \$4.95
- Decker, D.J., J.W. Kelley, T.W. Seamans, and R.R. Roth. 1983. Wildlife and timber from private lands: a landowner's guide to planning. Info. Bull. 193. NYS Coll. of Ag. and Life Sci., Cornell U., Ithaca. 56 pp. \$4.95
- Gill, J.D., and W.M. Healy. 1974. Shrubs and vines for northeastern wildlife. USDA For. Serv. Gen. Tech. Rep. NE-9. Northeastern For. Exp. Sta., Upper Darby, Pa. 180 pp.
- Gullion, G.W. 1983. Managing woodlots for fuel and wildlife. Ruffed Grouse Society, Coraopolis, Pa. 16 pp.
- Gullion, G.W. 1984. Managing northern forests for wildlife. Ruffed Grouse Soc., Misc. J. Series Publ. 13442, Minn. Agric. Exp. Sta., St. Paul. 72 pp.
- Gullion, G.W. Shrub and tree planting for ruffed grouse. Ruffed Grouse Society, Coraopolis, Pa. 10 pp.
- Gullion, G.W. Improving ruffed grouse habitat with proper planting. Ruffed Grouse Society, Coraopolis, Pa. 8 pp.
- Gullion, G.W. Integration of wildlife production into Great Lake States' forestry programs. Ruffed Grouse Society. Scientific J. Series Publ. No. 11,879, Minn. Agric. Exp. Sta., St. Paul. pp. 231-238.
- Gutierrez, R.J., D.J. Decker, R.A. Howard, Jr., and J.P. Lassoie. 1984. Managing small woodlands for wildlife. Inf. Bul. 157. NYS Coll. of Ag. and Life Sci., Cornell Univ., Ithaca. 32 pp.
- Hassinger, J., L. Hoffman, M.J. Puglisi, T.D. Rader, and R.G. Wingard. 1979. Woodlands and wildlife. Penn. St. Univ., Univ. Park, PA. 68 pp. \$2.00
- Hassinger, J., C.E. Schwarz, and R.G. Wingard. 1981. Timber sales and wildlife. Pennsylvania Game Commission. 13 pp.
- Henderson, C.L. Woodworking for wildlife. Minn. Dept. Nat. Resources. Nongame Wildlife. Program. 47 pp.
- Henderson, C.L., Landscaping for wildlife. Minn. Dept. Nat. Resources Nongame Wildlife Program, 47 pp.
- Kubisiak, J.F. 1987. Oak forests: a management opportunity for ruffed grouse and other wildlife. Ruffed Grouse Society, Coraopolis, PA. 18 pp.
- Hobson, S.S., J.S. Barclay, and S.H. Broderick. 1993. Enhancing wildlife habitats: A practical guide for forest landowners. Northeast Regional Agricultural Engineering Service, Ithaca. 172 pp. \$20.00
- Martin, A.C., H.S. Zim, and A.L. Nelson. 1951. American wildlife and plants. Dover Publications, Inc., New York. 500 pp.
- McCaffery, K.R., J.E. Ashbrenner, and J.C. Moulton. 1981. Forest opening construction and impacts in northern Wisconsin. Wis. Dept. Nat. Resour. Tech. Bull. 120.41 pp.
- Ruff, R.L., D.F. Covell, J.A. Nosek, and S.R. Craven, 1993. A bibliography of Cooperative Extension Service literature on wildlife, fish, and forest resources. Dept. of Wildlife Ecology, Coop. Ext. Prog., Univ. of Wisconsin-Madison. 116 pp.
- Sepik, G.F., R.B. Owen, and M.W. Coulter. 1981. A landowner's guide to woodcock management in the northeast. University of Maine, Life Science and Ag. Exp. Sta., Misc. Rep. 253. 23 pp.

### Ruffed grouse ecology

- Atwater, S. and J. Schnell, eds. 1989. Ruffed grouse. Stackpole Books, Harrisburg, Penn. 370 pp.
- Bump, G., R.W. Darrow, F.C. Edminster and W.F. Crissey. 1947. The ruffed grouse—life history, propagation, management. New York Conserv. Dept., Albany. 915 pp.
- DeStefano, S., S.R. Craven, and R.L. Ruff. 1984. Ecology of the ruffed grouse. Wisconsin Coop. Ext. Serv. G3252.
- DeStefano, S., R.L. Ruff, and S.R. Craven. 1983. A grouse in the hand. Wisconsin Coop. Ext. Serv. G3227.
- Dorney, R.S. 1959. The relationship of ruffed grouse to forest cover types in Wisconsin. Wis. Conserv. Dept. Tech. Bull. 18. 32 pp.
- Edminster, F.C. 1947. The ruffed grouse—its life story, ecology and management. MacMillan Co., New York. 385 pp.

- Gullion, G.W. The ruffed grouse. Ruffed Grouse Society, Coraopolis, Pa. 4 pp.
- Johnsgard, P.A. 1973. Grouse and quails of North America. Univ. of Nebr. Press, Lincoln. 553 pp.
- Kubisiak, J.F. 1978. Brood characteristics and summer habitats of grouse in central Wisconsin. Wis. Dept. Nat. Resour. Tech. Bull. 108. 11 pp.
- Kubisiak, J.F. 1985. Ruffed grouse habitat relationships in aspen and oak forests of central Wisconsin. Wis. Dept. Nat. Resour. Tech. Bull. 151. 22 pp.
- Kubisiak, J.F. 1985. Ruffed grouse harvest levels and population characteristics in central Wisconsin. Wis. Dept. Nat. Resour. Research Rep. 136. 24 pp.
- Kubisiak, J.F., J.C. Moulton, and K.R. McCaffery. 1980. Ruffed grouse density and habitat relationships in Wisconsin. Wis. Dept. Nat. Resour. Tech. Bull. 118. 15 pp.
- Madson, J. 1969. Ruffed grouse. Winchester Press, Olin Mathieson Chemical Corp., East Alton, Ill. 103 pp.
- Robinson, W.L., ed. 1984. Ruffed grouse management: state of the art in the early 1980's. North Cent. Sec. Wildl. Soc. 181 pp.
- Rue, L.L. 1973. The world of the ruffed grouse. J.B. Lippincott Co., Phil. and New York. 160 pp.
- General wildlife**
- Anon. 1990. Beaver damage control. Wis. Dept. Nat. Resour. 30 pp.
- Barquest, G., S. Craven, and R. Ellarson. 1982. Shelves, houses and feeders for birds and squirrels. Wisconsin Coop. Ext. Serv. G2091. 32 pp.
- Craven, S.R., and G.J. Knudsen. 1982. Snakes of Wisconsin. Wisconsin Coop. Ext. Serv. G3139. 8 pp.
- Craven, S.R., and R.L. Ruff. 1982. Bird feeding: tips for beginners and veterans. Wisconsin Coop. Ext. Serv. G3176. 12 pp.
- Dumke, R.T. 1982. Habitat development for bobwhite quail on private lands in Wisconsin. Wis. Dept. Nat. Resour. Tech. Bull. 128. 49 pp.
- Gregg, L. 1984. Population ecology of woodcock in Wisconsin. Wis. Dept. Nat. Resour. Tech. Bull. 144. 51 pp.
- Gromme, O.J. 1963. Birds of Wisconsin. University of Wisconsin Press, Madison. 236 pp.
- Jackson, H.H.T. 1961. Mammals of Wisconsin. University of Wisconsin Press, Madison. 504 pp.
- Les, B.L. 1979. The vanishing wild: Wisconsin's endangered wildlife and its habitat. Wis. Dept. Nat. Resour. 36 pp.
- Leopold, A. 1933. Game management. Charles Scribner's Sons, New York. 481 pp.
- Leopold, A. 1949. A sand county almanac. Oxford Univ. Press, New York. 226 pp.
- Liscinsky, S.A. 1972. The Pennsylvania woodcock management study. Penn. Game Comm., Harrisburg. 95 pp.
- Vogt, R.C. 1981. Natural history of amphibians and reptiles of Wisconsin. Milwaukee Pub. Mus. 208 pp.
- Field guides**
- Borror, D.J., and R.E. White. 1970. A field guide to the insects. Peterson Field Guide Series, Houghton Mifflin Co., Boston. 404 pp.
- Bull, J., and J. Farrand, Jr. (eds.). 1977. The Audubon Society field guide to North American birds - eastern region. Alfred A. Knopf, New York. 784 pp.
- Burt, W.H., and R.P. Grossenheider. 1980. Field guide to the mammals. Peterson Field Guide Series, Houghton Mifflin Co., Boston. 289 pp.
- Courtenay, B., and J.H. Zimmerman. 1972. Wildflowers and weeds. Van Nostrand Reinhold Co., New York. 144 pp.
- Fassett, N.C. 1976. Spring flora of Wisconsin. University of Wisconsin Press, Madison. 413 pp.
- Hamerstrom, F. 1972. Birds of prey of Wisconsin. Wis. Dept. Nat. Resour. 64 pp.
- Murie, O.J. 1975. A field guide to animal tracks. Peterson Field Guide Series, Houghton Mifflin Co., Boston. 375 pp.
- Peterson, R.T. 1980. A field guide to the birds. Peterson Field Guide Series, Houghton Mifflin Co., Boston. 384 pp.
- Petrides, G.A. 1972. A field guide to trees and shrubs. Peterson Field Guide Series, Houghton Mifflin Co., Boston. 428 pp.
- Robbins, C.S., B. Bruun, and H.S. Zim. 1966. Birds of North America. Golden Field Guide Series, Golden Press, New York. 340 pp.
- Forestry and woodland management**
- Anon. 1977. Tree planting in Wisconsin. Wis. Dept. Nat. Resour. 15 pp.
- Anon. 1988. Aspen management on your land. Wis. Dept. Nat. Resour. PUBL-WM-162.
- Beaufeaux, M., and G. Cunningham. 1984. Wisconsin woodlands: pine plantation management. Wisconsin Coop. Ext. Serv. G1983. 4 pp.
- Curtis, J.T. 1959. The vegetation of Wisconsin, University of Wisconsin Press. Madison. 657 pp.
- Harris, L.D. 1984. The fragmented forest. Univ. of Chicago Press, Chicago. 211 pp.
- Hauge, C., S. Hovde, and E. Steigerwaldt. 1985. Wisconsin woodlands: Christmas tree shearing. Wisconsin Coop. Ext. Serv. G3268. 4 pp.
- Huebschmann, M., and J. Martin. 1986. Wisconsin woodlands: estimating and interpreting site index. Wisconsin Coop. Ext. Serv. G3361. 4 pp.
- Huebschmann, M., and J. Martin. 1987. Wisconsin woodlands: intermediate cuttings in forest management. Wisconsin Coop. Ext. Serv. G3398. 6 pp.
- Kozlowski, T.T. 1984. Wisconsin woodlands: how forest trees grow. Wisconsin Coop. Ext. Serv. G3277. 7 pp.
- Lindberg, R.D., and H.J. Hovind. 1986. Wisconsin's forests - an assessment, 1985. Wis. Dept. Nat. Resour. Pub. FR-041. 86 pp.
- Lorimer, C.G., and C.T. Locey. 1983. Wisconsin woodlands: managing northern hardwood stands. Wisconsin Coop. Ext. Serv. G3229. 6 pp.
- Martin, J. 1985. Wisconsin woodlands: measuring trees and estimating volume. Wisconsin Coop. Ext. Serv. G3332. 7 pp.
- Martin, J. 1986. Wisconsin woodlands: estimating stocking conditions in your timber stand. Wisconsin Coop. Ext. Serv. G3362. 8 pp.
- Perala, D.A. 1977. Manager's handbook for aspen in the North Central States. USDA For. Serv. Gen. Tech. Rep. NC-36, North Cent. For. Exp. Sta., St. Paul. 30 pp.
- Reinke, M.E. Management of aspen. Packaging Corp. of America. Ruffed Grouse Society. 4 pp.

- Robson, T.F., and G.R. Cunningham. 1979. Wisconsin woodlands: forestry terms. Wisconsin Coop. Ext. Serv. G3018. 10 pp.
- Sander, I.L. 1977. Manager's handbook for oaks in the North Central States. USDA For. Serv. Gen. Tech. Rep. NC-37, North Cent. For. Exp. Sta., St. Paul. 35 pp.
- Smith, W.B. 1986. Wisconsin's fourth forest inventory: area. USDA For. Serv. Resour. Bull NC-97, North Cent. For. Exp. Sta., St. Paul. 48 pp.
- Steele, T., and G. Cunningham. 1983. Wisconsin woodlands: buying a safe chainsaw. Wisconsin Coop. Ext. Serv. G3206. 4 pp.
- Tubbs, C.H. 1977. Manager's handbook for northern hardwoods in the North Central States. USDA For. Serv. Gen. Tech. Rep. NC-39, North Cent. For. Exp. Sta., St. Paul. 29 pp.
- Wooden, A.L., C. Locey, and G. Cunningham. 1990. Lake states woodlands: aspen management. Wisconsin Coop. Ext. Serv. G3162. 6 pp.
- Wisconsin woodlands: safe tree harvesting. Wisconsin Coop. Ext. Serv. G3205.
- Wisconsin woodlands: protective clothing for chainsaw operators. Wisconsin Coop. Ext. Serv. G3177.
- Controlling wildlife damage**
- Craven, S.R. 1981. Controlling woodpecker damage. Wisconsin Coop. Ext. Serv. G3117. 2 pp.
- Craven, S.R. 1983. Protecting gardens and landscape plantings from rabbits. Wisconsin Coop. Ext. Serv. G1654. 8 pp.
- Craven, S.R., and S. Hygnstrom. 1986. Controlling deer damage in Wisconsin. Wisconsin Coop. Ext. Serv. G3083. 12 pp.
- Craven, S.R., and F. Iwen. 1980. Bats: information for Wisconsin homeowners. Wisconsin Coop. Ext. Serv. G3096.
- Hygnstrom, S., and S.R. Craven. 1986. Controlling: hawk and owl damage. Wisconsin Coop. Ext. Serv. 4 pp.
- Financial considerations**
- Barrows, R. 1984. Wisconsin's farmland preservation program. Wisconsin Coop. Ext. Serv. G2890. 4 pp.
- Barrows, R., A.J. Klingelhoets, T. Krauskopf, and D. Yanggen. 1980. Mapping to preserve agricultural land. Wisconsin Coop. Ext. Serv. A3038. 20 pp.
- Gerleman, T.G., and D. Last. 1985. Wisconsin's recreational use statute - limiting the liability of private landowners. Wisconsin Coop. Ext. Serv. G3326. 3 pp.
- Last, D., and T.G. Gerleman. 1984. Wisconsin's trespass law — controlling the use of private land. Wisconsin Coop. Ext. Serv. G3296. 2 pp.
- Martin, A.J., K. Potter-Witter, and J. Lapidakis. 1989. Lake states woodlands: marketing timber. Wisconsin Coop. Ext. Serv. G3297. 6 pp.
- Lapidakis, J., A. Wooden, and G. Cunningham. 1981. Wisconsin woodlands: the Woodland Tax Law and the Forest Crop Law. Wisconsin Coop. Ext. Serv. G1549. 4 pp.
- Stier, J.C., R.E. Denney, and J. Lapidakis. 1984. Wisconsin woodlands: income tax considerations for forestland owners. Wisconsin Coop. Ext. Serv. G3298. 3 pp.
- Thlusty, W.G., and G.W. Rodgers. 1987. Wisconsin woodlands: the Managed Forest Law Program. Wisconsin Coop. Ext. Serv. G3413. 6 pp.
- USDA For. Serv. 1982. A guide to federal income tax for timber owners. Agr. Handbook 596. U.S. Gov. Print. Off., Wash., D.C. \$4.75.
- Yanggen, D., and R. Barrows. 1980. Zoning to preserve agricultural land. Wisconsin Coop. Ext. Serv. A3038. 14 pp.
- Tax guides**
- Bowlby, V.L. 1989. The Christmas tree taxation manual (ninth ed.). \$52. *Available from:* Bowlby Publishing Co., Inc. 310 N.W. Fifth St., Suite 103 Corvallis, OR 97330
- Haney, H.L. Jr., and W.C. Siegel. 1988. Federal income tax guide for timber owners. Free. *Available from:* USDA Forest Service Southern Forest Experiment Station 701 Loyola Ave. New Orleans, LA 70113
- Hoover, W.L. 1989. Timber tax management for tree farmers. \$20. *Available from:* American Forest Council 1250 Connecticut Ave., N.W. Suite 320 Washington, DC 20036
- Hoover, W.L., W.C. Siegel, G.A. Myles and H.L. Haney, Jr. 1989. Forest owners' guide to timber investments, the federal income tax, and tax recordkeeping. USDA Agricultural Handbook No. 681. USGPO Stock #001-000-4540-7. \$5. *Available from:* Superintendent of Documents U.S. Government Printing Office Washington, DC 20402-9325
- Record systems**
- Bowlby, V.L. 1986. Christmas tree taxation bookkeeping system. \$35. *Available from:* Bowlby Publishing Co., Inc. 310 N.W. Fifth St., Suite 103 Corvallis, OR 97330
- Haney, H.L., Jr. 1985. A guide to income tax records for tree farmers. Virginia Cooperative Extension Service Publication 420-090. Single copies free. *Available from:* Cooperative Extension Service Virginia Tech. University Blacksburg, VA 24061
- Myles, G.A., T.A. Sedbrook and D. Casey. 1985. Woodlands account book. Single copies free. *Available from:* State Forester Maryland Forest, Park and Wildlife Service Tawes State Office Building 580 Taylor Ave. Annapolis, MD 21401
- Blumenstock, B. 1981. Yankee woodlot journal. Single copies free. *Available from:* Cooperative Extension Service University of Maine Orono, ME 04469
- Stier, J.C. 1989. Financial record book for timber growers (second ed.). \$5. *Available from:* Department of Forestry University of Wisconsin 1630 Linden Dr. Madison, WI 53706



---

 APPENDIX A
 

---

### *Some common forestry terms*

- Advance reproduction:** Young trees at least 4.5 feet tall that can successfully compete for light and nutrients after the overstory is removed.
- Block:** Any group of trees that is managed as a unit; often synonymous with a stand.
- Bolt:** A short log or a squared timber cut from a log up to 8 feet in length and at least 8 inches in diameter at the small end.
- Clearcut:** A harvesting and regeneration technique that removes all the trees (regardless of size) on an area in one operation. Clearcutting is usually used with species like aspen that require full sunlight to reproduce and grow well. Produces an even-aged forest stand.
- Climax forest:** The final or self-perpetuating successional stage in a forest.
- Conversion:** Change from one forest type to another, either naturally through disturbance or succession, or artificially through harvesting and reforestation.
- DBH:** The tree Diameter at Breast Height (4.5 feet above the ground).
- Forest Type:** A group of tree species that, because of their environmental requirements and tolerances, commonly grow together. Tree examples of forest types are the sugar maple-basswood type, the oak-hickory type, and the aspen-paper birch type.
- Herbaceous plants:** Plants that die back annually to the ground level, as distinct from woody shrubs and trees.
- Mast:** The nuts, seeds and fruits produced by forest trees and shrubs.
- Mature tree:** A tree that has reached the desired size or age for its intended use. Size or age will vary considerably depending on the species and intended use.
- Merchantable:** Timber for which a market exists because it meets specifications for species, size, freedom from defect, etc.
- Mesic:** This describes a habitat site with intermediate soil moisture content, as opposed to xeric (dry) or hydric (wet).
- Old-growth:** A stand made up of trees that are older than the normal rotation age.
- Overmature:** A tree that has passed the desired size or age for its intended use and is beginning to decline in value.
- Plantation:** An artificially reforested area established by planting or direct seeding.
- Pole-timber:** A stand of trees with diameters ranging from 4 inches to approximately 8 to 12 inches.
- Regeneration:** The process of forest replacement or renewal. This may be done artificially by seeding or planting; or naturally by sprouting or natural seeding.
- Reproduction:** Young trees that will grow to become the older trees in the future forest.
- Rotation Age:** The number of years required to establish and grow trees to a specified size, product or condition of maturity.
- Sapling:** A small tree, usually between 2 and 4 inches DBH.
- Sawlog:** A log large enough to produce a sawn product—usually at least 10 to 12 inches in diameter at the small end.
- Sawtimber:** A stand of trees with diameters greater than 10-12 inches.
- Seedling:** A tree, usually less than 2 inches DBH, that has grown from a seed.
- Seed-tree cut:** Removing all trees from the harvest area at one time except for a few selected trees left to provide seed to establish a new forest stand.
- Selection cut:** Harvesting individual trees or small groups of trees at periodic intervals (usually 8 to 15 years) based on their physical condition or degree of maturity. Produces an uneven-aged stand.
- Shearing:** The non-commercial removal of unmerchantable trees, using a chain saw or a bulldozer with a sharpened (KG) blade. Also refers to shaping of Christmas trees.
- Shelterwood cut:** Removing trees from a harvest area in a series of two or more cuttings so new seedlings can establish and grow in the partial shade and protection of older trees. Produces an even-aged forest.
- Site:** 1. A tract of land with reasonably uniform soil and climatic factors. 2. An area evaluated as to its capacity to produce a particular forest or other vegetation based on the combination of biological, climatic and soil factors.
- Site index:** An expression of forest site quality based on the height of the dominant trees at a specified age (usually 50 years in the eastern U. S.).
- Slash:** The brush accumulated from a cutting operation.
- Sprout:** A tree growing from the base, stump or root of another tree.
- Stand:** Any identifiable group of trees—by age, species, height, site, origin, stocking, management, etc.
- Thinning:** Generally, a cutting in an immature forest stand to reduce the tree density and concentrate the growth potential on fewer, higher quality trees resulting in larger trees with faster growth.
- TSI (Timber Stand Improvement):** The thinning of timber stands by removing inferior trees to improve stand quality and/or species composition.



---

 APPENDIX B

*Sources of publications*

Cornell Cooperative Extension Publications  
 Distribution Center C  
 7 Research Park  
 Cornell University  
 Ithaca, NY 14850

Department of Forestry  
 University of Wisconsin-Madison  
 1630 Linden Drive  
 Madison, WI 53706

Forest Resources Extension  
 Pennsylvania State University  
 Box 6000  
 University Park, PA 1680

North Central Forest Experiment Station  
 U.S. Forest Service  
 1992 Folwell Avenue  
 St. Paul, MN 55108

Northeast Regional Agricultural  
 Engineering Service  
 Cooperative Extension  
 152 Riley-Robb Hall  
 Ithaca, NY 14853-5701

The Ruffed Grouse Society  
 451 McCormick Road  
 Coraopolis, PA 15108-9327

University of Wisconsin-Extension  
 Cooperative Extension Publications  
 Rm. 245  
 30 N. Murray Street  
 Madison, WI 53715  
 (608) 262-3346

Wisconsin Department of Natural Resources  
 Bureaus of Research, Endangered Resources,  
 Forestry, or Wildlife Management  
 Box 7921  
 Madison, WI 53707



---

 APPENDIX C

## *Sources of wildlife plants*

In addition to free nursery stock available to Project Respect and Acres for Wildlife participants, DNR nurseries in Hayward, Wisconsin Rapids and Boscobel also sell stock suitable for wildlife plantings. Most counties also deliver orders from state nurseries. You can obtain a Tree and Shrub application form and delivery details from your local DNR office beginning in October or November. These trees often sell out early, so submit your order for the spring as quickly as possible. If you miss out on these, many county Land Conservation Departments take orders for conservation trees beginning in late winter.

You can also obtain nursery stock from private nurseries that deal in native grasses, forbs, aquatics, and woody plants for prairie and wetland restoration or wildlife plantings. The following nurseries requested to be included on a DNR list of tree sources for the Conservation Reserve Program. (This list is based in part on an inquiry sent to all licensed nurseries in the state, but does not represent a complete list of native or wildlife plant nurseries in Wisconsin. For informational use only, it does not imply endorsement of specific products or services, nor criticism of nurseries not listed, by the authors, UW-Extension, or the Wisconsin DNR.)

### *Iowa*

Cascade Forestry Service  
Rt. 1 Cascade, IA 52033  
(319) 852-3042

### *Minnesota*

Chippewa Farms  
Rt. 1, Box 246 Brandon, MN 56315  
(612) 524-2244

Itasca Greenhouse, Inc.  
Box 273 Cohasset, MN 55721  
(800) 538-8733

Spruce Pine Farms  
Hwy. 52 Fountain, MN 55935  
(507) 268-4466

### *Missouri*

Forrest Keeling Nursery  
Elsberry, MO 63343 (314) 898-5571

### *Wisconsin*

Brehm's Wonder Creek Farm  
Rt. 2, Beaver Dam, WI 53916

Gress Evergreen Inc.  
W7035 Hwy 64, Bryant, WI 54418  
(715) 623-6167

Borkenhagen Evergreen Acres  
W6472 Lake Ellen Dr., Cascade, WI  
53011 (414) 528-8872

Stumpf's Trees, Inc.  
340 Horns Corners Rd., Cedarburg, WI  
53012 (414) 375-1554

Lindsey Nursery  
8832 County V, Chili, WI 54420  
(715) 676-3681

Arneson Nursery  
Rt. 3 Box 1263, Clintonville, WI 54929  
(715) 823-6784

Trees for Tomorrow, Inc.  
Box 609 611 Sheridan, Eagle River, WI  
54521 (715) 479-6456

Lowes Creek Tree Farm  
311 Eisenhower St., Eau Claire, WI  
54701 (715) 834-7664

Bruce J. Miller International  
Box 66, Germantown, WI 53022  
(414) 255-4360

Ron Williams Nursery  
2310 Elmwood, Green Bay, WI 54313  
(414) 434-2847

WALI Nursery  
Rt. 9 Box 9089, Hayward, WI 54843  
(715) 462-3565

Wolfrath's Nursery  
N2988 Hwy 45, Hortonville, WI 54944  
(414) 779-6493

Bruce J. Miller Nursery & Seeds  
3187 Bark Lake Rd., Hubertus, WI  
53033 (414) 255-4360

Nursery Tree Farm  
W1659 County S, Kaukana, WI 54130  
(414) 766-3110

Glen Flora Nursery  
Rt. 1, Kiel, WI 53042 (414) 773-2493

Lake Mills Nursery, Inc.  
W7628 Conservation Rd., Lake Mills,  
WI 53551 (414) 648-2034

Silver Creek Nurseries Inc.  
Box 2114, Manitowoc, WI 54220  
(414) 684-1225

Northern Christmas Tree  
Growers and Nursery  
Hwy. 12 Box 19, Merrillan, WI 54754  
(715) 333-2661 or 5441

Schmeling Nursery  
S76W12723 McShane Dr.,  
Muskego, WI 53150

Clear Lake Nursery  
1296 Clearlake Rd., Milton, WI 53563  
(608) 868-4226

Sand Creek Nursery  
Rt. 2 Box 271, New Auburn, WI 54727

Detlor Tree Farm  
Box 6, Plainfield, WI 54966  
(715) 335-4444

Laura's Lane Nursery  
Box 232, Plainfield, WI 54966  
(715) 366-2477

Windfall  
504 S. East St., Plainfield, WI 54966  
(715) 335-6725

Suthers Moundview Nursery  
30746 Hwy 151, Platteville, WI 53818  
(608) 348-8991

Nepco Lake Nursery  
Nekoosa Papers Inc.,  
Port Edwards, WI 54469  
(715) 887-5301

Insti Trees  
7014 Fire Tower Rd. Box 137,  
Rhineland, WI 54501  
(715) 282-5247

Krueger's Northwoods Nursery  
3682 Limberlost Rd.,  
Rhineland, WI 54501  
(715) 369-3959

Wis-Con-Trees  
809 Keenan St., Rhineland, WI  
54501 (715) 362-3364

Northern Woodsman Products  
W1177 Washington Rd.,  
Rubicon, WI 53078 (414) 474-4098

St. Croix Valley Trees  
458 Rice Lake Rd.,  
Sommerset, WI 54025 (715) 247-5500

West Wisconsin Nursery &  
Christmas Trees  
Rt. 4 Box 141, Sparta, WI 54656  
(608) 272-3171

Evergreen Nursery Co., Inc.  
5027 County TT,  
Sturgeon Bay, WI 54235  
(414) 743-4464

Pony Creek Nursery  
Box 16, Tilleda, WI 54978  
(715) 787-3889

Betthausen's Nursery  
Rt. 3, Tomah, WI 54660  
(608) 372-4317

Lodholz North Star Acres  
420 Hwy. A, Tomahawk, WI 54487  
(715) 453-2976

Westfork Walnut Nursery  
Rt. 3, Viroqua, WI 54665  
(608) 637-2528

Birnamwood Nursery  
603 Sturgeon Eddy,  
Wausau, WI 54401  
(715) 842-8719

Paradise Gardens Nursery  
1848 Hwy 33 East,  
West Bend, WI 53095 (414) 338-8316

Sigourney's Tree and Nursery  
1080 Cooke Ave.,  
Wisconsin Rapids, WI 54494  
(715) 423-4465

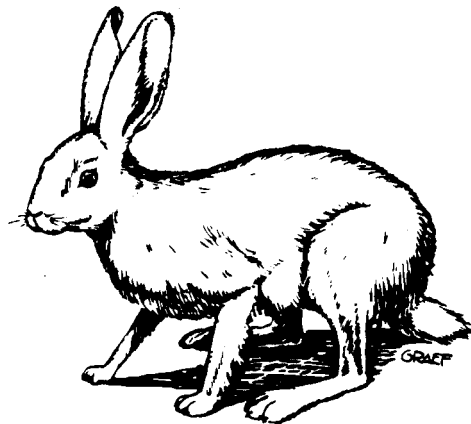

The following is a list of sources for seeds, tubers and plants of native Wisconsin vegetation. It was compiled by landscape architect John Diekelmann and Drs. Evelyn Howell and John Harrington of the UW-Madison Department of Landscape Architecture. (This list is for informational use only and does not constitute endorsement by the compilers or the authors.)

### *Illinois*

Lafayette Home Nursery  
c/o Jock Ingalls, Lafayette, IL 61449

Windrift Prairie Nursery  
c/o Dorothy & Doug Wade, Rt. 2,  
Oregon, IL 61061

### *Minnesota*

Orchid Gardens  
Rt. 1, Grand Rapids, MN 55744

Prairie Restorations  
c/o Ron Bowen, Rt. 3,  
Princeton, MN 55371

### *Wisconsin*

Boehlke's Woodland Gardens  
W140 N1089 Country Aire Rd.,  
Germantown, WI 53022

Great Lakes Wild Flowers  
Box 1923, Milwaukee, WI 53201

Prairie Ridge Nursery  
c/o Joyce Powers, Rt. 2, Overland  
Road, Mount Horeb, WI 53572

Prairie Seed Source  
c/o Robert Ahrenhoerster, Box 83,  
North Lake, WI 53064

Kester's Wild Game Food  
Nurseries  
Box V, Omro, WI 54963

Strand Nursery Co.  
Osceola, WI 54020

Wildlife Nurseries  
Box 2724, Oshkosh, WI 54903

Little Valley Farm  
Rt. 1, Box 287,  
Richland Center, WI 53581

Prairie Nursery  
c/o Neil Diboll  
Box 116, Rt. 1, Westfield, WI 53964



## APPENDIX D

*Cavity-using birds of Wisconsin\**

## KEY

E = Excavator:

1 = Primary excavator; digs own cavity

2 = Secondary excavator; uses existing cavities

T = Type:

L = Live tree

D = Dead tree (snag)

DT = Diameter of tree in inches

FD = Floor dimensions of cavity in inches

DC = Depth of cavity in inches

ED = Entrance (hole) diameter in inches

EF = Entrance height above floor of cavity in inches

HG = Cavity height above ground in feet

Species	E	T	DT	FD	DC	ED	EF	HG	Habitat
Wood Duck	2	L	16	12x12	24	4.0	19	6-40	<i>Bottomland hardwoods &lt; 0.5 mile from water</i>
Common Goldeneye	2	L	23	12x12	24	4.5	19	6-40	<i>Hardwoods adjacent to northern lakes</i>
Hooded Merganser	2	L	20+	10x10	24	4.0	19	20+	<i>Wooded, clear-watered streams and lakes</i>
Common Merganser	2	L	20+	10x10	35	4.7	20		<i>Hardwoods near cool, clear waters</i>
Turkey Vulture	2	D	20+						<i>Most forest types, use forest openings</i>
Peregrine Falcon	2		20+						<i>Open country along waters</i>
Merlin	2		20+						<i>Open stands of hardwood forests</i>
American Kestrel	2	L	12	8x8	14	3.0	11	10-30	<i>Brushy borders and open or semi-open country</i>
Common Barn Owl	2	L	20+	10x18	17	6.0	4	12-18	<i>Forests, barnyards, marshes and fields</i>
Eastern Screech Owl	2	L	12	8x8	11	2.5	9	12-20	<i>Widely spaced tree with grassy open spaces</i>
Northern Hawk Owl	2	L	20+						<i>Northern forests with openings and bogs</i>
Boreal Owl	2	D	12					10-25	<i>Conifer-hardwood mixed forests</i>
Northern Saw-whet Owl	2	L	12	6x6	11	2.5	9	12-20	<i>Deep northern forests</i>
Chimney Swift	2	L	20+						<i>Woody &amp; open areas &amp; man-made structures</i>
Common Flicker	2	D	15	7x7	17	2.5	15	6-20	<i>Near large trees in open woodlands a&amp; fields</i>
Pileated Woodpecker	1	D	22	8x8	20	4.0	11	12-60	<i>Extensive mature forest areas</i>
Red-bellied Woodpecker	1	L	18	6x6	13	2.5	11	12-20	<i>Common in southeastern forests</i>
Red-headed Woodpecker	1	D	20	6x6	14	2.0	11	12-20	<i>Open areas —farm yards, field edges</i>
Yellow-bellied Sapsucker	1	D	12	5x5	10	1.5		12-20	<i>Along streams in mixed conifer-hardwood forests</i>
Hairy Woodpecker	1	L	12	6x6	14	1.5	11	12-20	<i>Open woodlands and forests</i>
Downy Woodpecker	1	D	8	4x4	9	1.2	7	6-20	<i>Open woodlands, orchards and urban areas</i>

\*Adapted from Tubbs, C.H., R.M. DeGraaf, M. Yamasaki and W.M. Healy. 1987. Guide to wildlife tree management in New England northern hardwoods. Gen. Tech. Rep. NE-118. Broomall, PA:USDA, Forest Service, Northeastern Forest Experiment Station, 30 pp.





## KEY

E = Excavator:

1 = Primary excavator; digs own cavity

2 = Secondary excavator; uses existing cavities

T = Type:

L = Live tree

D = Dead tree (snag)

DT = Diameter of tree in inches

FD = Floor dimensions of cavity in inches

DC = Depth of cavity in inches.

ED = Entrance (hole) diameter in inches.

EF = Entrance height above floor of cavity in inches.

HG = Cavity height above ground in feet.

Species	E	T	DT	FD	DC	ED	EF	HG	Habitat
Black-backed Woodpecker	1	D	12	5x5	10	2.0		7-15	<i>Northern conifer forests</i>
Great-crested Flycatcher	2	L	12	6x6	9	2.0	7	8-10	<i>Forests and forest-field edge areas</i>
Tree Swallow	2	D	12	5x5	6	1.5	3	10-15	<i>Usually near water in open areas</i>
Purple Martin	2	D	12	6x6	6	2.5	1	15-20	<i>Open areas and cutover forests</i>
Black-capped Chickadee	1	D	4	4x4	9	1.1	7	5-15	<i>Brushy borders and forests</i>
Boreal Chickadee	1	D	4	4x4	9	1.1	7	5-15	<i>Northern forests of spruce, fir and aspen</i>
Tufted titmouse	2	D	12	4x4	9	1.2	7	6-15	<i>Eastern deciduous woodlands</i>
White-breasted Nuthatch	2	L	12	4x4	10	1.2	7	5-20	<i>Deciduous woodlands</i>
Red-breasted Nuthatch	2	D	12	4x4	10	1.2	7	5-15	<i>Conifer-aspen woodlands</i>
Brown Creeper	2	D	12						<i>Coniferous forests</i>
House Wren	2	L	12	4x4	7	1.0	3	6-10	<i>Brushy borders and edge habitat</i>
Winter Wren	2	L	8	4x4	7	2.0	5	5-10	<i>Forest brushpiles and thick undergrowth</i>
Bewick's Wren	2	L		4x4	7	1.0	3	6-10	<i>Farmyards, brushlands, fencerows and suburbs</i>
Carolina Wren	2	L		4x4	7	1.1	3	6-10	<i>Forests with thick undergrowth</i>
Eastern Bluebird	2	D	8	5x5	8	1.5	6	5-10	<i>Brushy borders around open areas</i>
European Starling	2			6x6	17	2.0	15	10-25	<i>Parks, suburbs and farms</i>
Prothonotary Warbler	2	D	8	4x4	8	1.5	5	4-7	<i>Swamps and deciduous forests near water</i>
House Sparrow	2			4x4	9	1.5	7	4-12	<i>Cities, suburbs and farms near humans</i>



## APPENDIX E

## *Wisconsin's Recreational Use Statute*

### *Limiting the injury liability of private landowners*

Thomas G. Gerleman and Donald Last

In 1984, the Wisconsin legislature revised the recreational use statute. The new law limits property owners' responsibility for people who use their land for recreation.

Except for some special situations described elsewhere, landowners do not have a legal obligation to:

1. keep their property safe for recreational activity;
2. inspect their property; or
3. give warning of an unsafe condition, use or activity on their property.

The law also eliminates liability of property owners for injuries to a person engaged in a recreational activity when the injuries are caused by another recreational user or a wild animal.

*EXAMPLE 1: Grant Door receives permission to hunt on Florence Clark's property. While hunting, Grant is accidentally shot by another hunter. Florence Clark is protected by the statute. She is not liable for Grant Door's injury.*

This publication provides a summary and interpretation of the key provisions of the new law. Persons wishing more information on this subject should consult an attorney or get a copy of the statute from a library or courthouse (Wis. Stats. 895.52).

#### *What is a recreational activity?*

The state statute defines recreational activity as "any outdoor activity undertaken for the purpose of exercise, relaxation or pleasure, including practice or instruction in any such activity." The statute specifically lists 30 examples which fall within this general definition.

Wisconsin's new recreational use statute defines recreational activity as "any outdoor activity undertaken for the purpose of exercise, relaxation or pleasure, including practice or instruction in any such activity." The statute specifically lists the following examples of such activity:

*hunting, bird-watching, ballooning, hiking, sleigh riding, snowmobiling, skating, sightseeing, animal training, outdoor games, bicycling, motorcycling, hang gliding, camping, sledding skiing, water sports, cutting/removing wood, outdoor sports, outdoor education, horseback riding, fishing trapping, tobogganing, picnicking, exploring caves, nature study, rock-climbing, climbing observation towers, harvesting the products of nature.*

#### *Under what circumstances are landowners liable?*

The state's recreational use statute describes certain circumstances in which an owner may be liable for an injury to a person using his property. For example, the law does not limit or eliminate liability if a land owner sponsors a spectator sport since "organized team sport" is specifically excluded from the definition of recreational activity in the statute.

*EXAMPLE 2: Langlade Richland sponsors a softball tournament on land he owns. During the tournament, a foul ball hits and injures Rock St. Croix. Richland is not protected by the recreational use statute. St. Croix may initiate a lawsuit against Richland.*

A private property owner's liability likewise is not limited if that owner receives more than \$2,000 annually from those using his property

for recreation. These payments may be in the form of money or an equivalent amount of goods or services and must have been received during the year in which the injury took place. Commercial recreational businesses therefore may be liable for injuries to guests or clients.

However, individuals may collect no more than \$5 per person per day for permission to gather products of nature, may receive payments from the government or nonprofit groups for the management/conservation of the property's natural resources, and may receive a share of the harvested products of nature from a recreational user. Such payments are not included in the \$2,000 payment rule described above.

*EXAMPLE 3: Forest Sawyer charges a daily user fee to skiers and snowmobilers. His total receipts are more than \$20,000 annually. Forest Sawyer's injury liability is not reduced by the recreational use statute.*

*EXAMPLE 4: Douglas Dodge sometimes receives a share of the fireplace wood cut and removed from his woodlot by Pierce Marquette. Dodge is not liable if Marquette is injured while engaged in this activity.*

The law does not limit liability for an injury to a recreational user if the injury is caused by the malicious failure of the owner (or the owner's employee or agent) to warn the user about an unsafe condition known to the owner.

*EXAMPLE 5: A group of teenagers receive permission from Price Taylor to operate motorized three-wheelers on his land. Taylor at the time was aware that a recent tornado had scattered broken glass and nails in the area the group planned to ride. He deliberately withholds this information because he "wants to teach the kids a lesson." One of the teens was injured by the broken glass. In any subsequent lawsuit, if Taylor's malicious intent is proved, he is not protected by the recreational use statute.*

*EXAMPLE 6: Lincoln Adams received permission to hunt on Monroe Washington's land. Adams asks Washington if there is anything to watch out for. Washington says "no" because he is unaware that a recent heavy rain has washed out part of a pathway. Adams later stumbles in the washout and breaks his leg. Because Washington was not aware of the hazard, he is protected by the statute.*

A property owner may be liable for an injury to a social guest who is expressly and individually invited for the occasion during which the injury occurs, but only if the injury took place: 1) on platted land (generally land that has been developed); or 2) on residential property (a building designed and used as a private dwelling, and the land around the building within a 300-foot radius); or 3) on property which is within 300 feet of a building or structure that is legally classified for mercantile or manufacturing use.

*EXAMPLE 7: Vernon Sauk has a tennis court next to his home. Sauk invites Ashland Burnett to play a game of tennis. Burnett is injured while jumping over the net. Burnett can sue Sauk because the injury occurred within 300 feet of his home. Vernon Sauk invites Calumet Wood to ride one of his newly purchased horses. The horse bolts and Wood injures a hip in falling off. Because the accident happened several hundred yards from Sauk's home and outbuildings, Sauk is protected from a lawsuit by Wood.*

A property owner is liable for injuries to employees if they are acting within the scope of their duties. Therefore, this statute does not prevent an employee who sustains an injury while on the job from suing an employer.

*EXAMPLE 8: Juneau Dunn owns two dairy farms located several miles from each other. Dunn's farmhand, Walworth Green, sometimes uses a motorbike to travel between farms. Green skids in loose gravel one day and is injured. Because Green was acting within the scope of his employment, the recreational use statute does not protect Dunn from liability. Another Dunn farmhand, Barron Brown, invites several friends to ride dirt bikes on his day off. While riding on Dunn's land, Brown is thrown from the bike and cracks a collarbone. Even though Brown is Dunn's employee, the recreational use statute limits Dunn's liability because the dirt-bike riding is outside the scope of Brown's responsibilities as a farm employee.*

### *Summary*

Wisconsin's recently revised recreational use statute protects private (as opposed to commercial) property owners by limiting their legal responsibility for persons who may be injured while using that owner's land for recreational purposes. A recreational activity is defined as nearly every outdoor pursuit except organized team sports.

In general, property owners are not liable for injury to a recreational user that is caused by the natural conditions of the land, by other recreational users, or by wild animals. Owners may be liable for injuries to recreational users of their land if they fail to warn about a hazard known to them, or if they have a malicious intent to injure the user. There are other situations in which landowners may be liable, such as when an injury occurs to an invited guest near the home or near a building used for selling or making something, or when the owner receives a substantial payment for the recreational usage.

Wisconsin's recreational use statute serves to clarify the legal responsibility of property owners who allow others to use their land for outdoor exercise, relaxation or pleasure. People who use an owner's land without permission are *Trespassing*. They are subject to arrest and conviction under another section of state law. This law, as recently amended, is explained in a publication entitled *Wisconsin's Trespass Law*, available from county University of Wisconsin-Extension offices.



## APPENDIX F

### *Sample Timber Sale Contract*

This Contract is entered into by and between \_\_\_\_\_ of \_\_\_\_\_ (Seller),  
and \_\_\_\_\_ of \_\_\_\_\_ (Purchaser).

The Seller hereby authorizes the Purchaser to enter upon the following described lands, (the Premises); for purposes of cutting and removing timber marked or otherwise designated by the Seller.

Those Premises are further described on the map(s) or diagram(s) attached to and made a part of this Contract.

FOR AND IN CONSIDERATION of the following terms and conditions the Seller and the Purchaser mutually agree:

#### CONTRACT PERIOD AND TERMINATION

1. Time is of the essence, therefore, the Purchaser shall cut all timber or forest products described in paragraph 6 and complete all other performance described herein with reasonable diligence so performance is completed no later than \_\_\_\_\_. The period of this contract commences upon its signing by both parties and the Purchaser providing the owner with all required bonds and certificates of insurance.

2. The Seller or Agent shall notify the Purchaser in the event of a breach of any condition of the Contract at which time all operations shall immediately cease, and continued occupancy on the Premises shall be a trespass. Upon notification, operations may not be resumed nor may timber be cut or removed without written authorization from the Seller.

3a. The Purchaser has deposited cash, a surety bond, a certified check, or other form acceptable to the Seller in the amount of \$ \_\_\_\_\_ as a performance bond, to assure proper performance and to be held until the completion of all conditions of the Contract to the satisfaction of the Seller.

b. Upon breach of any condition of this Contract, the performance bond shall be applied to actual damages incurred by the Seller.

c. If timber or other forest products not specifically described in this Contract or designated by the Seller for cutting are cut, damaged or removed by the Purchaser, the Seller may pursue any and all remedies for the unlawful use of the Seller's property and the cutting, damage or removal of property without consent, including the seeking of criminal or civil charges for theft, timber theft or criminal damage to property in addition to its Contract remedies for breach.

d. The Seller's damages upon the Purchaser's failure to perform this Contract include, but are not limited to: (1) The Purchaser's bid value of timber not cut and removed under this Contract. (2) Double the mill value, as determined by the Seller, for timber cut, removed or damaged without authorization under or in violation of this Contract. (3) All costs of sale area cleanup, restoration or completion of performance not completed by the Purchaser. (4) All costs of resale of timber not cut and removed as required under this Contract.

e. Additional damage provisions:

4. No forest products may be removed from the Premises until the products are paid for by the Purchaser or guarantees for payment satisfactory to the Seller are provided.

5. Title to any forest products cut under this Contract shall remain with the Seller until payment is received.

#### PRODUCTS TO BE REMOVED

6. The Purchaser is authorized and shall cut, remove and pay for the following timber or forest products during the period of this contract:

**PAYMENTS**

7a. LUMP SUM SALE:

(a) The Purchaser agrees to pay Seller an amount of \$\_\_\_\_\_ to be paid under the following schedule:

(b) The Seller is not obligated to return the payment in part a, or any portion of it in the event the Purchaser fails to remove all timber or forest products authorized for removal.

b. SCALE PRODUCTS SALE: (As an alternative to a lump sum payment, the payment may be designated by price per cord or MBF per species with an estimate of forest products available.) Payment to the Seller shall be made based upon the following and as further described herein:

SPECIES	PRODUCTS	ESTIMATED VOLUME	PRICE PER UNIT		TOTAL ESTIMATED VALUE
			MBF FT	CORD	
<hr/>					
TOTAL					

8. Log and tree volumes shall be determined by the Scribner Decimal C system.

9. Cord means a standard measure of piled wood 4' x 4' x 96" to 100". Cord products of other dimensions shall be converted to standard cords.

**UTILIZATION**

10. Maximum stump height shall not exceed stump diameter, and for stumps of diameter less than 10 inches it shall not exceed 10 inches.

11. Timber or forest growth, whether mature or not, may not be damaged through careless operations or unnecessary equipment use.

12. The Purchaser agrees to complete all operations as described herein without waste or nuisance on the premises.

13. Additional equipment and operation requirements:

**NOTICE OF INTENT TO CUT AND COMPLIANCE WITH LAWS**

14. The \_\_\_\_\_ shall make and file a written declaration to the county clerk of his or her intention to cut forest products pursuant to section 26.03, Stats., and comply with all other notice requirements and laws and ordinances with respect to work under this Contract.

**SLASH AND DEBRIS DISPOSAL**

15. Slash falling in any lake or stream, in a right-of-way or on land of an adjoining landowner shall be immediately removed from the waters, right-of-way or adjoining land. Tops from felled trees may not be left hanging in standing trees. All trees shall be completely felled and not left leaning or hanging in other trees.

16. Other slash disposal requirements:

17. The Purchaser shall remove, to the satisfaction of the Seller, all solid waste, trash and debris generated by the Purchaser.

**ROADS, CAMPS, SURVEY CORNERS**

18. Location, construction, and use of logging roads, mill sites and camp sites is subject to advance approval by the Seller. All such areas or facilities used or constructed by the Purchaser must be operated, maintained and restored prior to termination of the Contract in a manner satisfactory to the Seller. Purchaser shall repair damage to existing roads .

19. Logging roads that intersect town, county, or state roads or highways must have the intersections approved by the proper authorities prior to construction and cleared of all unsightly debris at the time of construction.

20. The Purchaser agrees to pay for the cost of repair or replacement of property or any land survey monuments or accessories which are removed or destroyed or made inaccessible.

21. Other restoration requirements (i.e., seeding, gravel, rutting, culvert removal, etc.):

22. Erosion control requirements:

**LIABILITY**

23. The Purchaser agrees to protect, indemnify and save harmless the Seller and the Seller's employees and agents from and against all causes of action, claims, demands, suits, liability or expense by reason of loss or damage to any property or bodily injury to any person, including death, as a direct or indirect result of timbering operations under this contract or in connection with any action or omission of the Purchaser, who shall defend the Seller in any cause of action or claim. In addition, the Purchaser agrees to furnish the Seller with a certificate of insurance of current coverage under the Worker's Compensation Law, Chapter 102, Stats., and public liability insurance for the period of logging operations on the Seller's property in the amount of:

- a. Personal injury: \$300,000 single limit liability or \$100,000 bodily injury per person and \$300,000 per occurrence.
- b. Property damage: \$100,000.

**GENERAL**

24. The Purchaser is an independent contractor for all purposes including Worker's Compensation and is not an employee or agent of the Seller. The Seller agrees that the undersigned Purchaser, except as otherwise specifically provided herein, shall have the sole control of the method, hours worked, time and manner of any timber cutting to be performed hereunder. The Seller reserves the right only to inspect the job site for the sole purpose of insuring that the cutting is progressing in compliance with the cutting practices established under this Contract. The Seller takes no responsibility for supervision or direction of the performance of any of the harvesting to be performed by the undersigned Purchaser or of its employees. The Seller further agrees that it will exercise no control over the selection and dismissal of the Purchaser's employees.

25. The Seller agrees to initially designate the timber to be sold and may make inspections for the purposes of ascertaining whether the timber has been cut and the Contract has been complied with. All work shall be performed in a workman-like manner. Work shall be performed in accordance with the requirements of the contract. The parties stipulate that in fulfillment of the terms of this timber sale Contract, the Seller warrants that the Seller has clear and unencumbered title to the stumpage subject to this Contract.

26. The purchaser agrees to take reasonable precautions to prevent the starting and spreading of fires. The Purchaser is responsible for damage and forest fire suppression costs, including that provided in ss. 26.14 and 26.21, Wis. Stats., caused by the Purchaser's operation under this contract.

27. This Contract or work under it may not be assigned or subcontracted in part or in whole without prior written approval from the Seller and may be changed or amended only in writing. The Purchaser agrees to notify the surety, if any, of any such change or amendment.

28. This Contract, together with specifications in the request for bids as well as reference to parts and attachments, shall constitute the entire agreement and any previous communications or agreements pertaining to this Contract are hereby superseded. Any amendments to this Contract shall be in writing signed by both parties.

Date \_\_\_\_\_ Seller \_\_\_\_\_

Date \_\_\_\_\_ Purchaser \_\_\_\_\_

Date \_\_\_\_\_



---

NOTES





---

NOTES



---

**Authors:** Scott R. Craven and Robert L. Ruff are professors of wildlife ecology with the College of Agricultural and Life Sciences, University of Wisconsin–Madison and wildlife specialists with the University of Wisconsin–Extension, Cooperative Extension. Darrel Covell is a wildlife ecology outreach specialist with the College of Agricultural and Life Sciences, University of Wisconsin–Madison. John Kubisiak is a biologist with the Wisconsin Department of Natural Resources. Stephen DeStefano was a project associate with the Department of Wildlife Ecology, University of Wisconsin–Madison and is currently a research associate with the Oregon Cooperative Research Unit at Oregon State University.

Issued in furtherance of Cooperative Extension work, Acts of May 8 and June 30, 1914, in cooperation with the U.S. Dept. of Agriculture, University of Wisconsin–Extension, Cooperative Extension. University of Wisconsin–Extension provides equal opportunities in employment and programming, including Title IX and ADA requirements. If you need this information in an alternative format, contact the UWEX Affirmative Action Office or Extension Publications at (608)262-2655.

*This publication is available from your Wisconsin county Extension office or from Extension Publications, Rm. 245, 30 N. Murray St., Madison, WI 53715, (608)262-3346.*

G3578 A LANDOWNER'S GUIDE TO WOODLAND WILDLIFE MANAGEMENT  
*with emphasis on the ruffed grouse*



I-02-94-2M-500-S